



LEON CUP RACER



2016 LCR
MANUAL DE USUARIO
USER MANUAL

INDEX

1	TECHNICAL INFORMATION	3
1.1	Leon Cup Racer Display.....	3
1.2	Dimensions and weights.....	4
1.3	Body shell	5
1.4	Powertrain.....	6
1.5	Electronic units.....	8
2	DRIVERS CONTROL	9
2.1	Main console	9
2.2	Steering wheel module	9
2.3	Display alarms and shift lights	10
2.4	Gear lever functions	12
2.5	Car launching systems	13
2.6	Speed limiter system.....	14
2.7	Driver has to consider	14
3	Electronics	16
3.1	AIM MXG	16
3.2	MXG connection schemes	17
3.3	Data acquisition analysis.....	18
3.4	Fusebox	20
3.5	Fuel level display	22
3.6	Auxiliary connectors	23
4	SETTING ADJUSTMENTS	26
4.1	Base car set-up.....	26
4.2	Steering rack centering.....	27
4.3	Suspension.....	27
4.4	Front camber and toe adjustment.....	27
4.5	Rear camber and toe adjustment.....	28
4.6	Dampers.....	29
4.7	Antiroll bars.....	31
4.8	Kinematics	32
4.9	Brakes	34



TECHNICAL MANUAL LEON CUP RACER

4.10	Aero	35
5	WORKSHOP MANINTENANCE	36
5.1	FIRST ROLLOUT	36
5.2	Check list	36
5.3	Vehicle & parts identification.....	37
5.4	Fluids information	38
5.5	Engine service.....	39
5.6	Air filter	39
5.7	Gearbox	41
5.8	VAQ – Electronics differential	41
5.9	Fuel tank	42
5.10	Airjacks.....	45
6	PARTS MILEAGE.....	47
7	SAFETY	48

1 TECHNICAL INFORMATION

1.1 Leon Cup Racer Display

Engine

\ Type.....	Turbocharged; 4-cylinder in line
\ Fuel supply system.....	Direct fuel injection
\ Displacement (cc).....	1984 cc
\ Bore and stroke (mm).....	82,5 x 92,8
\ Maximum power (PS/rpm).....	330 HP/ 6250 rpm
\ Maximum torque (Nm/ rpm).....	410Nm / 2000 to 5000 rpm
\ Electronic control unit.....	Continental SIMOS
\ Exhaust / dB.....	Twin-end racing catalysed 114dB
\ Fuel tank.....	100 lts FIA FT3 (<i>check point 5.8</i>)
\ Speed limiter system	active 60km/h
\ Launch control system	active

Transmission

\ Transmission.....	Front-wheel-drive
\ Gearbox.....	6 speed DSG
\ Differential.....	VAQ ellectronically managed
\ Clutch.....	Multi disc oil cooled
\ Shift control.....	Electronic on steering wheel

Chassis and Suspension

\ Front suspension.....	McPherson, adjustable in height, toe and camber
\ Anti-roll bar.....	Front and rear adjustable
\ Rear suspension.....	Multi-link, adjustable in height, toe and camber
\ Front brakes.....	6-piston callipers, 378 mm steel ventilated discs
\ Rear brakes.....	272 mm steel discs
\ Brake pedal.....	Unitary with brake balance regulation
\ Steering system.....	Full Ellectrical power steering rack
\ Rims.....	SEAT Sport 10"x18"
\ ABS / TCS.....	Optional

Body and aerodynamics

\ Roll bar.....	FIA Homologated
\ Weight.....	1.190 kg
\ Front Width (max).....	1.950 mm
\ Rear Width (max).....	1.950 mm
\ Length.....	4.547 mm
\ Wheel base.....	2.665 mm

Car check-control

\ Acquisition system.....	AIM - MXG
\ Diagnostics.....	Auto-diagnosis OBDII / DiagRA - LE
\ Airjack.....	Complete car kit
\ Firer extinguishing system.....	OMP CESAL 2

1.2 Dimensions and weights

Dimensions		
Overall length	4547 mm	
Overall bodywork front width	1950 mm	Measured on the mud-ward at the front axle
Overall bodywork rear width	1950 mm	Measured on the mud-ward at the rear axle
Wheel base	2665 mm	
Over hang front splitter	897 mm	
Over hang front bumper	867 mm	
Over hang rear	825 mm	
Over hang rear wing	160 mm	From the wing vertical to the bumper
Minimum ground clearance	free	70 mm is the performance recommendation

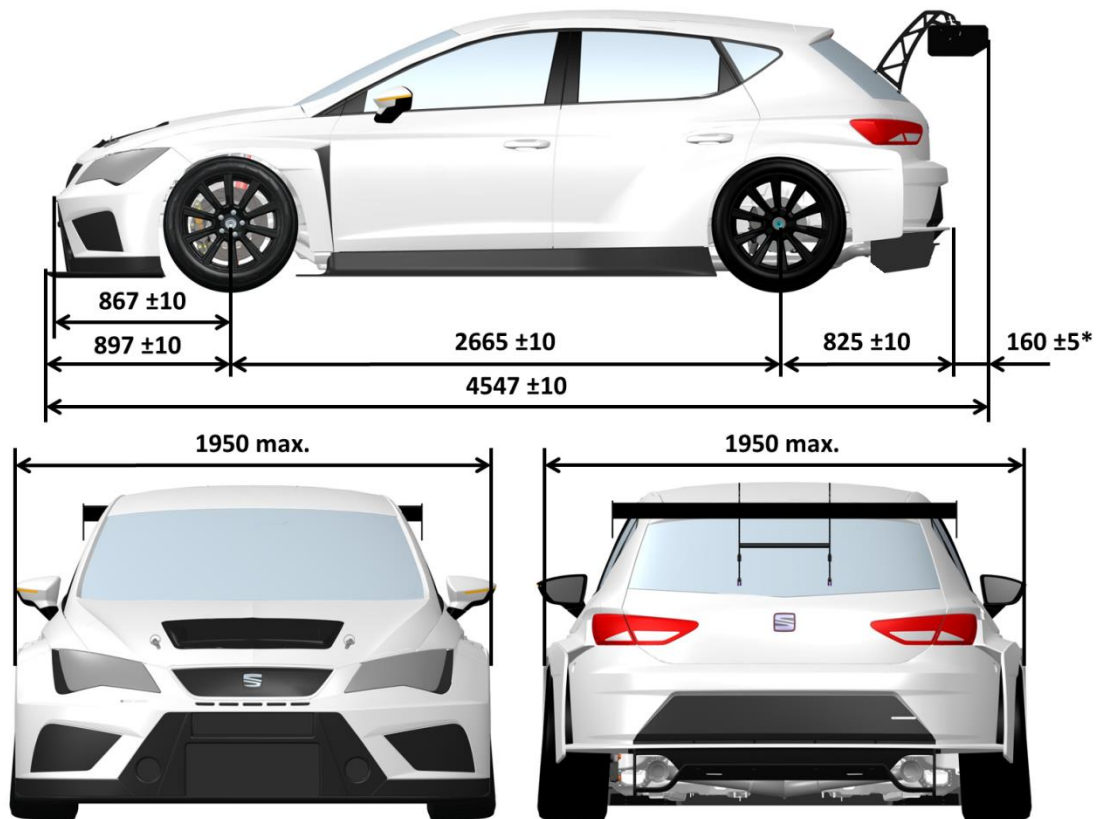

Weight:	
Total weight in race conditions without fuel	1190 kg
Car balance	62% front <-> 38% rear
Distribution weight/power	3,6 kg/cv

Notes:

- * Measured from the rear bumper to the end of rear wing profile.

1.3 Body shell

Part number	Description	Material
01	Bonnet	Steel
02	Left / right front door	Steel
03	Left / right rear door	Steel
04	Roof	Steel
05	Boot lid	Steel
11	Bonnet opening	Carbon
12	Front splitter	Carbon
13	Fender air exit	Carbon
14	Front bumper	Fiberglass
15	Rear bumper	Fiberglass
16	Left / right side trim	Carbon, Kevlar & Fiberglass
17	Left / right rear door extension	Carbon (painted)
18	Left / right rear fender extension	Carbon (painted)
19	Left / right front fender	Carbon (painted)
20	Diffuser	Carbon
21	Windscreen	Glass
22	Left / right front door window	Glass
23	Left / right rear door window	Glass
24	Left / right rear triangle window	Plastic
25	Rear window	Plastic

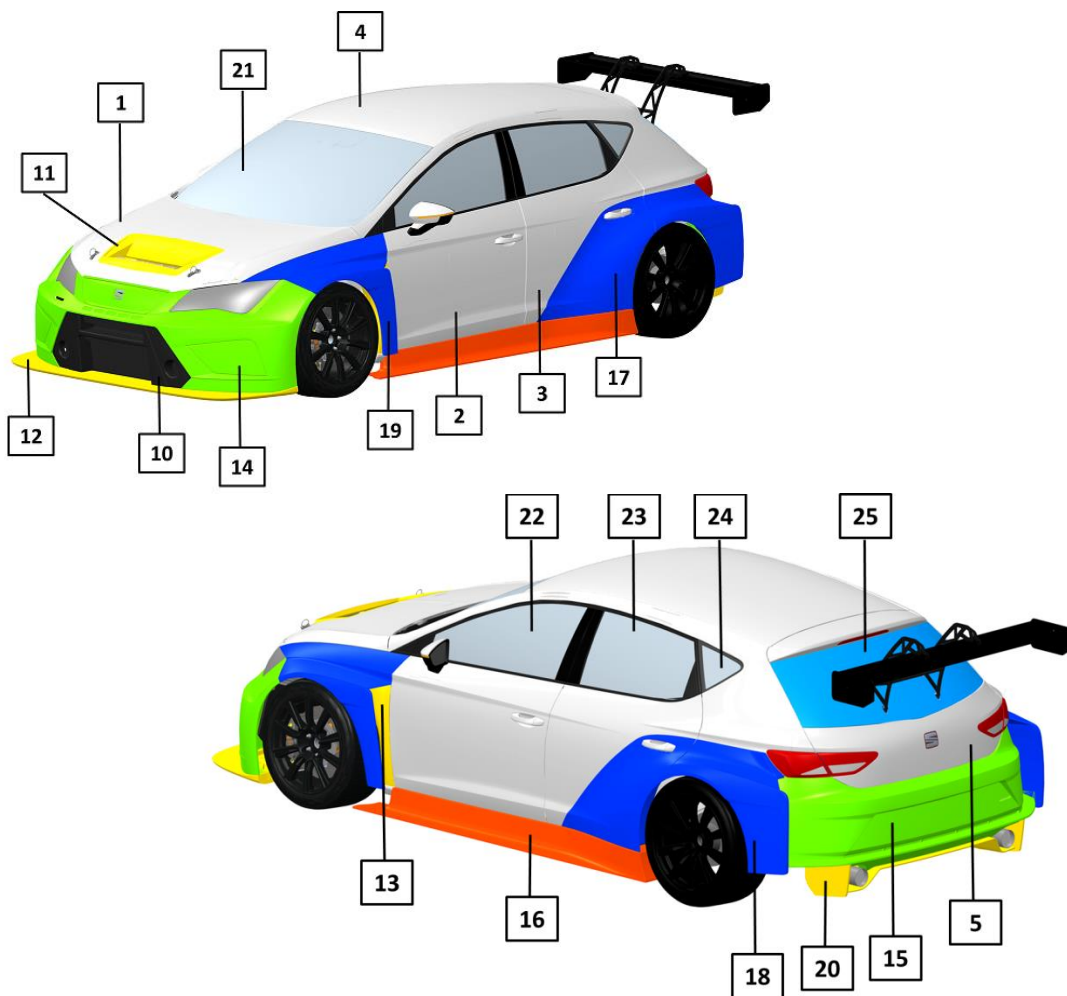

1.4 Powertrain

ENGINE FEATURES	
Type	2,0 TSI / Turbocharged & direct injection
Engine identification	CJX
Cylinder capacity	1984 cc
Corrected cylinder capacity	1984 x 1,7 = 3372,8
Maximum power	242 KW (330 Hp) at 6250rpm
Maximum torque (Nm/ rpm)	410 Nm at 4600 rpm
Max rpm	6800 rpm
Specific Power	165 CV/l
Electronic control unit	CONTINENTAL SIMOS 18.1
Fuel	RON MIN 98 , RON MAX 102
Fuel Consumption	0,37 to 0,42 l/km
Exhaust / dB	Racing Catalyst FIA Homologated / 104 dB
Distribution	Chain (sealed)
Oil system	Wet sump
Water pump	One electric water pump + two auxiliary pumps
Water thermostat	Double electronic thermostat
Fan range	Operating range 92°C to 87°C

Engine power and torque curve:

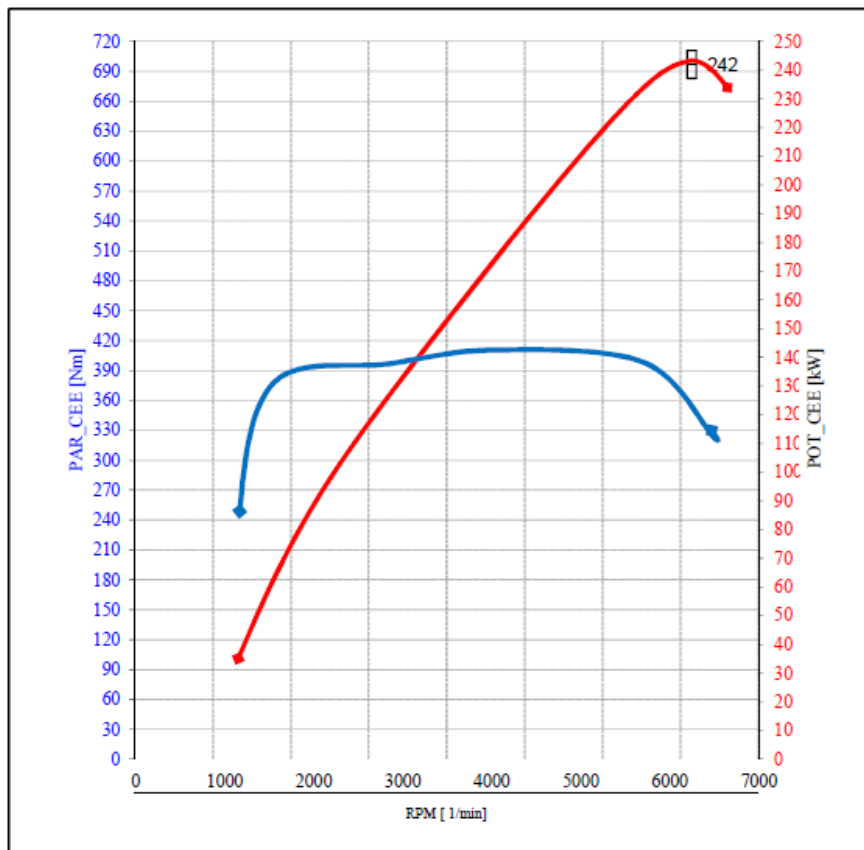

Fuel tank features	Description
Fuel tank type	FIA FT3 homologated fuel tank
Capacity	104 l ±2%
Minimum fuel level before engine fault	Less than 1 litre
Ventilation valve	FIA homologated roll-over, ventilation and 200 mbar pressure regulator valve
Refuelling	Safety FIA plug

Gearbox features	
Transmission	Front wheel drive
Gearbox	6 speed DSG
Differential	VAQ Electronic slip differential
Differential settings	3 Map available.
MAP 1	Base mode, No OverSlip, Only yaw damping in speeds above 110km/h. 300 Nm prelock during braking. <i>Recommended use when grip is high. (new tyres or good grip)</i>
MAP 2	Like map 1, less yaw damping, 200 Nm prelock during braking <i>Recommended use when medium grip. (used tyres)</i>
MAP 3	Prelock dependent from engine torque, 200 Nm prelock during braking(releasing earlier than 2) <i>Recommended use when grip is low or rain</i>
Clutch	Double multidisc clutch in oil bath
Gearbox mode command	Electronic on the central gear lever
Gear shift	Paddles on the steering wheel
Gearbox Electronic Control Unit	Integrated mechatronic in oil bath
Cooling system	Exchanger oil - water
Launch control system	Activated
Down shift over rev protection	Activated / 1sec memory

Gear box Ratios								
GROUP 1-2-3-4	15	72	0,208		83	180	189	DIF
GROUP 5-6	20	72	0,278		RPM1	SHIFT	CUT	
FINAL RATIO	1	1	1,000					
GEAR	Prim Z1	Sec Z2	Gear Relation	Total Relation	3000	6500	6800	DIF RPM
1st	13	38	0,342	0,071	26	56	58	
2nd	22	45	0,489	0,102	37	80	83	1952
3rd	28	41	0,683	0,142	51	111	117	1847
4th	38	41	0,927	0,193	70	151	158	1711
5th	32	35	0,914	0,254	92	199	208	1558
6th	38	35	1,086	0,302	109	236	247	1026

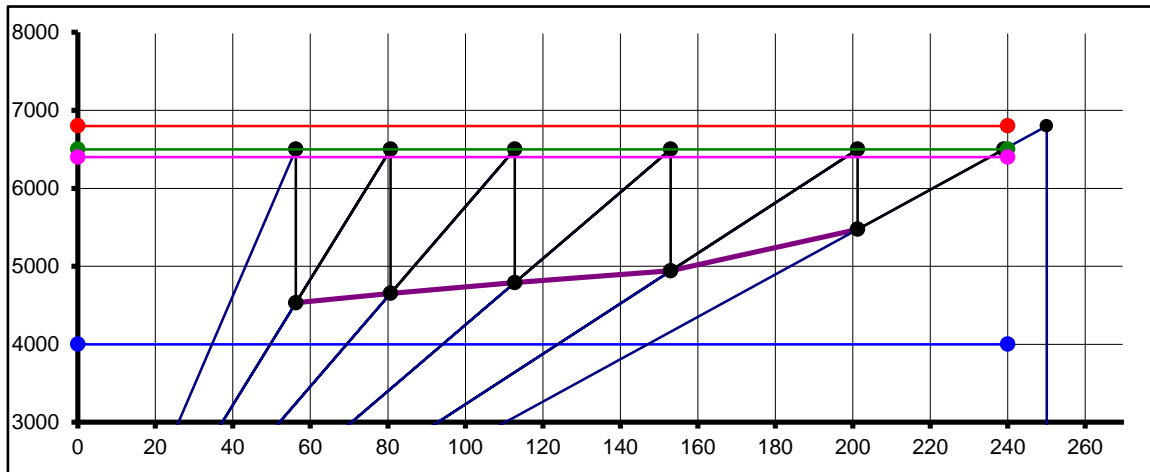

Suspension	Description	Remarks
Front damper -Bilstein-	2 way adjustable / Aluminium body	Click 10 bump / 10rebound
Springs Eibach front and rear	160/60/70 -80-90-100-110-120	Adjustable
Front Antiroll bar	22x2 // 22x3	Adjustable in 6 positions
Rear bumper -Bilstein-	2 way adjustable // Aluminium body	Click 10 bump / 10rebound
Rear Antirollbar	22 x3 // 22x4	

Brake car features	Description	Remarks
Front caliper	AP 6P	Special: SEAT Sport
Front disc	378 x 34	Special: SEAT Sport
Front pump	AP 19,1 mm	
Front pads	Pagid	Orange // Thick: 25 mm
Rear caliper	AP 2P	
Rear disc	272x10	Solid
Rear pump	AP 22,2 mm	
Rear pads	Pagid	Orange
Rear press reducer	valve 25 bar	(nominal)
Brake balance	Mechanical	

Tyre information	
Rim dimension	10"x 18" ET 36
Rim centre lock	5 studs x 112 mm
Maximum tyre dimension recommended	270/660 R18
Tyre temp difference inside / outside	20°C
Minimum cold pressure recommended	1.4 bar

1.5 Electronic units

Electronic MODULES	Remarks	Software	Place
ECU	Continental	Motorsport	Engine bay
Mechatronic	VW	Motorsport	Inside gear box
Electronic slip differential	BorgWarner	Motorsport	FDX (external)
Fuel pump control Unit	PWM control Unit	Series	Fuel tank (external)
Fuel pump	Audi	Series	In the fuel tank
Electronic Steering rack	VW	Motorsport	Front subframe
ESP unit	Continental	No active	Cockpit
Gateway	VW	Series adapted	Cockpit
Black box	Audi	Motorsport	Cockpit
MXG display / logger	AIM	Motorsport	Cockpit
Fuse box	SEAT Sport	Motorsport	Cockpit
Steering Driver module	SEAT Sport	Motorsport	Cockpit
Transponder	XXX		Engine bay

MODULES BASED IN SERIES	Engine	Mechatronic	Elec. Slip diff.	Low fuel pump	Steering rack	ESP	Gateway
Specific software/ mapping:	Yes	Yes	Yes	No	Yes	No	Yes
Specific codifications:	Yes	Yes	Yes	No	Yes	yes	yes
Interchangeable between cars:	Yes	No	No	Yes	Yes	Yes	Yes
Spare part ready for plug and play:	Yes	No	Yes	Yes	Yes	Yes	Yes
*UDS diagnosis (VW diagnosis):	Yes	Yes	Yes	Yes	Yes	Yes	Yes
Modification allowed:	No	No	No	No	No	No	No

Notes:

- Use always spare parts from SEAT Sport. Although the mentioned parts derive from series cars, the software and codifications are different and modified by SEAT Sport.
- All series modules used on the car are based in the MQB platform. Through the diagnostic tools available on the VW Group dealers, it is possible to diagnostic any malfunction.

2 DRIVERS CONTROL

In this section, it is explained how the driver can handle the different commands and functions of the SEAT Leon Cup Racer.

2.1 Main console

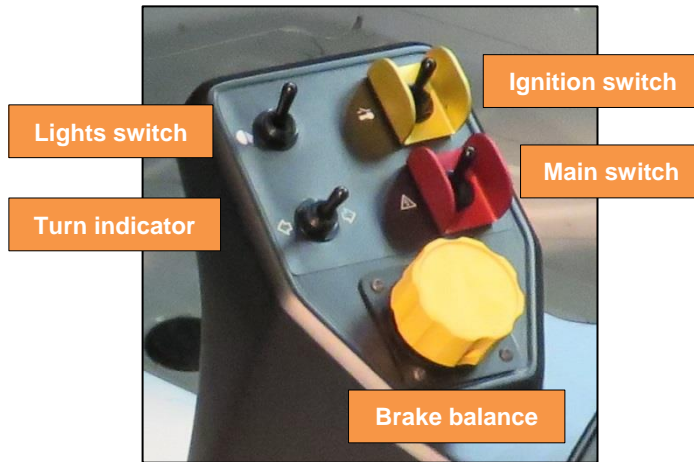

Function	Remarks
Ignition switch:	It activates the power to all devices. The Main Switch has to be active.
Main switch:	It activates the power supply.
Lights switch:	It activates the low beam. High beam and flash activation buttons are placed on the steering wheel module.
Turn indicator:	It activates the left and right turn lights. A green alarm on the display appears showing that the turn light is blinking.
Brake balance:	Turning the balance wheel you can balance the brake pressure from front to back or vice-versa. Do not press the brake pedal while moving the balance wheel. Through the driver display you can check the front and rear brake pressure and the balance in percentage.

Notes:

- To start the car, always proceed in this order: Main switch and later ignition switch. To stop the engine proceeds backwards.
- The correct procedure to stop the car is the following:
 1. Stop the engine using only the yellow switch (ignition switch/KL-15).
 2. Wait at least 60 seconds. If the waiting time is lower, the OBD faults memory is not saved.
 3. Switch off the car using the red switch (main switch/KL-30).

If this procedure is followed correctly the OBD faults memory is saved and these faults can be checked with the diagnostics tools at any time thereafter. These faults are saved until the memory is deleted manually using the diagnostics program.

The diagnostics tool DiagRA-LE is recommended for customers to be able to check the cars.















2.2 Steering wheel module

The electronic steering wheel module permits to activate different functions without living hands from the steering wheel.

Some buttons has double functionality



Steering wheel functions:

Nº	Function	Conditions / Remarks
1	 Starter	Active in gear lever in "P" or "N" Active if rpm < 500
	 Speed limiter	Short push to activate/deactivate, limit 60 km/h
2	 Diff map change 3 maps	Short push to increase differential map number The diff map scrolls rotatory with 3 maps Diff map number is showed on the display screen "driver 1" Map 1: Us when grip is high. (new tyres or good grip) Map 2: Use when medium grip. (used tyres) Map 3: Use when grip is low or rain
	 Traction control active/deactivate	ONLY WITH ABS UNIT ACTIVE (ABS optional) Pressing the button 3 seconds the TCS can be deactivated.
3	 Safety brake signal button	"Brake signal can be activate with this button in case of brake switch failure" Possible move the gear lever without push the brake pedal IMPORTANT: the use of this security button it's under the user responsibility.
4	 Radio	Driver voice activation Maintain pushed to talk
5	 Rain lights	Short push to toggle on/off
6	 Driver fan	Toggle to activate
7	 Change display	Press to change the display pages / rolling change
8	 High beam	Short push to flash Long push to toggle on/off
9	 Wiper	Toggle to activate.
10	 Windscreen water	Push to activate water splash + wiper activation
11	 Drink	Activates water pump Note: Pump not supplied with the car.
-- +	Tip up // Tip down	Orange led informs when tip up or down signal has been pressed
	CAN info	Usual status: LED off If there is a CAN Bus problem: Led on

Notes:

- Although it is possible uncouple completely the steering wheel from the column with the engine running, is not advisable. (Cause fault messages on the OBD).

2.3 Display alarms and shift lights

Car delivery alarm configuration































Gear	Shift Light 1	2	3	4	5	6	7	8	9	10	
All	6100	6100	6100	6300	6300	6300	6400	6450	6500	6600	



Notes:

- **LED 1 yellow alarm light:** Low oil pressure. If no red alarm follows you can continue. If alarm disappears you can continue pushing. Check the oil level when back into the pit.
- **LED 2 red alarm light + POP UP:** Very low oil pressure. Big risk to break the turbo or to damage the engine. Seat Sport recommends slowing down and entering to the pit-lane or stopping in a safe place.
- **LED 3 purple alarm light:** Battery voltage low warning. You can continue, check the alternator and the alternator poly-V belt.
- **LED 4 yellow alarm light:** Fuel pressure low warning. You can continue, check the fuel level.
- **LED 5 yellow alarm light:** water temperature high. Pay attention, drive out of slipstream and keep an eye on the values. If no red alarm follows you can continue. If alarm disappears you can continue pushing.
- **LED 6 red alarm light:** water temperature too high. Drive out of slipstream and keep an eye on the values. Some torque reductions will appear but you can continue.
- **LED 6 red alarm + POP-UP message:** Critical water temperature. Seat Sport recommends slowing down and entering to the pit-lane or stopping in a safe place, to avoid damaging the engine.
- **LED 7 white alarm light:** Gearbox oil temperature high. Drive out of slipstream and keep an eye on the values if not some torque reductions will appear. You can continue.
- **LED 8 blue alarm light:** Intake air temperature high. Drive out of slipstream and keep an eye on the values if not some torque reductions will appear. You can continue.
- **LED 8 red alarm light:** Steering initialization needed (it will appear each time the car is switched on). Turning the steering wheel left and right should disappear. If not, there is a problem in the electrical steering rack.



	<input checked="" type="checkbox"/> Events	Alarms						
↑ priority	<input checked="" type="checkbox"/>	ALARM Oil_Pressure 2	LED: 2		Output:	Message:		
	<input checked="" type="checkbox"/>	ALARM Oil_Pressure	LED: 1		Output:	Message: Low Oil Pressure		
	<input checked="" type="checkbox"/>	Oil Pressure_Popup	LED:		Output:	Popup Message: OIL PRESSURE		
	<input checked="" type="checkbox"/>	ALARM Fuel_Pressure	LED: 4		Output:	Message: FUEL PRESSURE LO		
	<input checked="" type="checkbox"/>	WATER TEMP POPUP	LED:		Output:	Popup Message: CRITICAL WAT		
	<input checked="" type="checkbox"/>	ALARM T_Water_2	LED: 6		Output:	Message: WATER TEMP TOO H		
	<input checked="" type="checkbox"/>	ALARM T_Water	LED: 5		Output:	Message: WATER TEMP HIGH		
	<input checked="" type="checkbox"/>	ALARM Gearbox_Temp	LED: 7		Output:	Message: GEARBOX TEMP HIGH		
	<input checked="" type="checkbox"/>	ALARM Air Temp	LED: 8		Output:	Message: AIR TEMPERATURE H		
	<input checked="" type="checkbox"/>	ALARM Battery	LED: 3		Output:	Message: Bat Voltage Low		
	<input checked="" type="checkbox"/>	Steering Wheel pos	LED: 8		Output:	Message: Steering Wheel Pos		

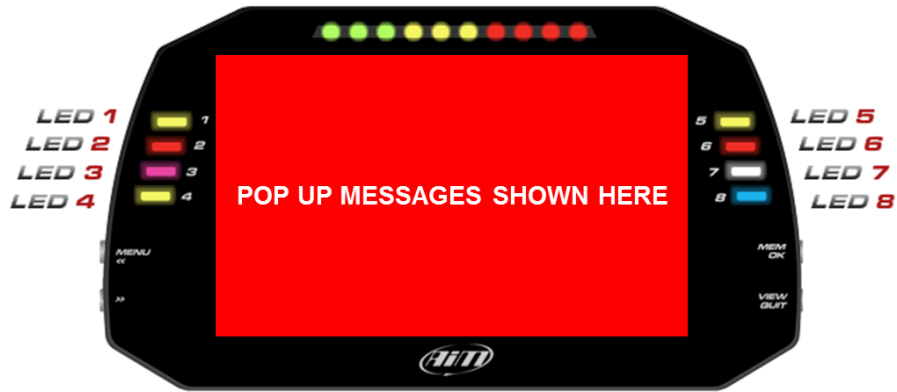

2.4 Gear lever functions

The shifting gear lever enables the different gear box modes. The features for each mode are:

Gear lever	Mode	Remarks
		
P	Parking mode	Use to lock the car. (Safety for team staff when car is stopped)
R	Reverse	<i>(not allowed on the pits zone)</i>
N	Neutral	No gear engaged. Traction is free.
D/S	Automatic mode	D= Automatic Drive S= Automatic Sport Drive
Tip +/- (TS)	Manual shifting	Shifting through the wheel paddles

“P” parking mode:

Use parking mode to lock the transmission through a mechanical cable. Use only this position when you want block the car.

- It's only possible lock or unlocks the parking mode if the car is completely stopped and the brake pedal is pressed.
- **IMPORTANT: Never try to put the gear lever in “P” if the car is not completely stopped. If this happens the gear box might be seriously damaged.**
- If for any reason is not possible to move the lever from “P” position although you are pressing the brake pedal, through the safety grey button “sign (P)” on the steering wheel module is possible to unlock the gear lever command.

“R” reverse mode:

- It's only possible to put on and take out the “R” (reverse) mode if the car is complete stopped and brake pedal is pressed.

“N” neutral mode:

- In “N” mode, it is possible to move the car pushing externally (pit lane use).

“D” automatic mode:

- Not advisable for race. “D” mode is only advisable to move the car on the paddock zone. The gear shifting is working in a low range of engine speed.

“S” automatic mode:

- Pushing the gear lever backward one time when lever is in “D” the **“S” mode will be engaged**. Driver display will show now “S”. (left up corner)
- Use “S” mode to drive in automatic shifting. Simultaneously is possible to use the steering paddles.
- It’s possible to use “S” mode in the launching system. The gear will shift up automatically. The driver can pass to Tip mode in any moment.
- It’s possible to pass from “D” or “S” to Tip and backwards always and in any moment.

“Tip” manual mode: “TS” (the most advisable for motorsport)

- From the “S” gear lever position move the gear lever to the right side. Driver display will show **“TS” mode**.
- Use “TS” mode for drive in manual mode, handling the shifting by the steering paddles.
- “TS” the shifting is manual. When the engine will reach rpm limit the power will limit (6800 rpm).
- Downshift is protected preventing the engine rpm overriding. Shift demand will be active for one second.

2.5 Car launching systems

There are two car launching systems for the standing starts, manual or automatic launch system.

“LCS” LAUNCH CONTROL SYSTEM -AUTOMATIC-

LCS allows you to perform a semiautomatic car launching. This system is automatically activated if wheels are absolutely stopped and brake pedal is pressed.

Launching time after brake signal pedal off:

Process:

1. After the grid formation lap, stop completely the car on the grid line pushing the brake pedal.
2. Gear lever has to be in **“S”** or **“TS”** mode. If this mode was already in during formation lap, will not be necessary move the gear lever.
3. Push foot throttle flat out. Engine will limit at ± 4200 rpm.
4. Release the brake pedal and car will be launched. Driver has to control the wheel spin with the gas pedal.

Summarizing: Arriving from the formation lap driving in “S” or “TS” stops the car on the grid line pressing the brake pedal. Push the foot throttle flat out (4200rpm) and release the brake when you decide. **(max time flat out 6 sec)**

Control the wheel spin and enjoy.

Notes:

- *Starting in “S” is necessary to release a little bit the gas pedal from the full gas to disable the launch system. After this, using the **“S”** mode, up shift is automatic.*
- *Is possible to use the Launch Control System controlling the rpm. Advisable no below of 3500 rpm.*
- *The system need brake press **>10 bar**. Push the brake pedal clearly.*
- *With start lights in red: If you release just a little bit the brake pedal in any moment of the system process will understand that launch is done and the clutch will load irreversibly.*

MANUAL LAUCH SYSTEM

It's possible to carry out a manual launching whit the same success.

Process:

1. After the grid formation lap, stops completely the car on the grid line.
2. Push the brake pedal (Brake press **>25 bar**)
3. Gear lever has to be in “**S**” or “**TS**” mode. If this mode was already in, it's not necessary move the gear lever.
4. Release the brake pedal while you press down the gas pedal.

Notes:

- *It's also possible to while you are braking put the engine in charge accelerating a little bit. **Take care the time you apply the engine charge because the clutch takes temperature very fast and after a certain limit the clutch launch is coming slow. Recommendation not more than 3 seconds.***

2.6 Speed limiter system

The speed limiter system allows limiting the car speed. This system is recommended for the pit lane area.

Speed limiter limitation is 60Km/h (tolerance - 2 km/h GPS speed)

Process:

1. Brake to reduce the car speed around 60 km/h or little less.
2. Release the brake and do a short push on the steering wheel red button.
3. Push the gas pedal fully. Car speed has to be limited.
4. Short push to deactivate the function.

Notes:

- Can be applied in different gears. Recommended 3rd or 4th gear.

2.7 Driver has to consider

- Learn and memorize the steering wheel buttons place and functions will allow drivers a more fast action and will help to not lose the track reference point.
- Warm up the engine before starting. The minimum water temperature before to load the engine is 80°C.
- Check the brake pedal is hard when car is standing and on the acceleration way.
- Warm up the tires before attacking. Without blankets use, the rear tires takes 2 laps to warm and this car is very sensitive on that.
- Shift up the gear when shift light indicates. With 410 Nm 2WD front its recommend shift around 6300 rpm.
- Shift down gears without stress. Automatic gearbox needs reduce engine rpm to permit the next shifting down. Do not shift down 3 times consecutively if the previous gear was not engaged. (memory active for 1 sec).
- Last lap: Cool down brakes and engine water to avoid the engine and discs thermal shock.
- Display alarms: There are three different possibilities to show alarms, 1) LEDs lateral, 2) red ribbon bellow screen 3) completely screen pop up message. Stops the engine if “pop up” message appears. (Oil or water). Speaks with your engineer about the alarms configuration.
- If for any reason you have to drop out the car on the track put the gear lever in “N” Neutral to save the transmission in case of being towed.

DISCS BEDDING PROCEDURE

To get the maximum life please follow the instructions below:

- Where possible bed discs with used pads.
- To reduce thermal shock during bedding the brake ducts may be 50% taped off.
- Apply the brakes gently at low speed a few times to ensure correct installation.
- Apply the brakes moderately, (progressively up to 50% race speed, 25% race pressure), for 10-20 applications to ensure above 80% pad face contact with disc. (The contact with the disc face is particularly important at the inner swept area. The first time a driver gets used to bedding discs on a car it is worthwhile getting him to return to the pits to check contact is sufficient before preceding to the next step).
- Progressively build up to about 70% of race speed and 50% of race pressure, then apply brakes for approximately 25 applications.
- Perform one lap cooling down before returning to the pits.
- The orange temperature paint should be turned on the surface and the green 75% of the way through the disc thickness at which point any tape can be removed. On returning to the track progressively come up to race speed and pressure.

RACING PAD AND ROTOR BEDDING PROCEDURE

First Bedding:

1st Gear – Gentle Applies

5 Snubs – Max Speed to nearly stopped – ± 20 Second Intervals

Second Bedding:

2nd Gear – Moderate Applies

20 Snubs – Max Speed to $\approx \frac{1}{2}$ Max Speed - ± 20 Second Intervals

Third Bedding:

3rd Gear – Hard Applies

20 Snubs – Max Speed to $\approx \frac{1}{2}$ Max Speed - ± 20 Second Intervals

Notes:

- 1 After Third Bedding allow brakes to cool to ambient
- 2 If significant fade occurs in any section increase interval time by 50%.

3 Electronics

3.1 AIM MXG

MXG is the new AiM dash-logger designed to acquire and display data coming from your ECU, the internal accelerometer and gyro, as well as from the GPS module, analog/digital inputs and predefined math channels.

Performance and data acquired can also be incremented adding expansion modules.

It's possible to scroll the pages through the steering wheel module black button (7).

To enable "the lap time" is necessary to insert the track where you are running. Track load has to be done by the program GPS Manager available at the sw RaceStudio3.

SmartyCam: The on-board cameras that overlays on videos the data sampled by your logger.



Software RaceStudio3, Firmware MXG and documentation available on the AIM web site:

<http://www.aim-sportline.com/eng/download/index.htm>

Display logger user guide available on the AIM web site:

http://www.aim-sportline.com/download/doc/eng/mxs-mxg/MXG_user_guide_101.pdf

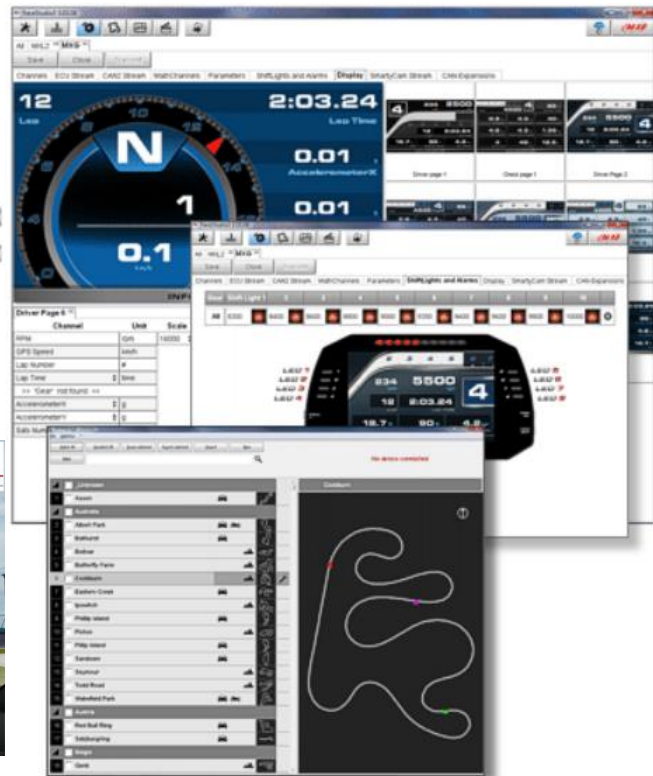

Features	Remarks
Lap-trigger	The MXG system uses only GPS signal.
Circuit	Through the RaceStudio3 software is possible to activate all the circuits in the world. It is also possible to create and load a new circuit.
Extra sensors	In case of adding extra sensors, they have to be connected to an expansion module. This expansion module has to be connected through the data hub as shown in the scheme 2.

Notes:

- Channel expansion module and sensors are available through AIM dealers, not SEAT Sport.
- If for any reason it is necessary to send data acquisition files to SEAT Sport, following data file extensions must be sent: .drk, .bak, .gpk, .rrk and .xrk.

3.3 Data acquisition analysis

AIM-MXG channel list:

Channel name	Description	Unit	Recommended scale
P_TURBO	Boost pressure	bar	0 ... 3
T_ENG_AIR	Intake air temperature	°C	20 ... 70
T_ENG_OIL	Engine oil temperature	°C	80 ... 150
T_ENG_WATER	Engine coolant temperature	°C	70 ... 125
T_AIR	External air temperature	°C	12 ... 45
RPM_ENG	Engine speed	rpm	1000 ... 7000
FLAG_BRAKE	Brake lights	on/off	0 ... 2
P_BRK_FRONT	Front brake pressure	bar	0 ... 100
P_BRK_REAR	Rear brake pressure	bar	0 ... 100
P_ENG_OIL	Engine oil pressure	bar	1,5 ... 5
P_ENG_FUEL	Fuel low pressure	bar	0 ... 7
FUEL_LEVEL	Fuel level	dm ³	0 ... 110
FUEL_CONS	Fuel consumed	dm ³	0 ... 110
S_FUEL	Fuel remaining time	min	0 ... 120
N_FUEL	Fuel remaining laps	#	0 ... 80
LAP_CONS	Fuel lap consumption	dm ³ /lap	0 ... 3
POS_PEDAL	Gas pedal position	%	0 ... 100
TIP_DOWN	Tip down	Sign	0 ... 2
TIP_UP	Tip up	Sign	0 ... 2
G_CH_Y	Lateral acceleration	G	-2,5 ... 2,5
G_CH_X	Longitudinal acceleration	G	-1,6 ... 1,6
W_CH	Yaw rate	°/s	-50 ... 50
V_WHL_RL	RL wheel speed	km/h	0 ... 260
V_WHL_RR	RR wheel speed	km/h	0 ... 260
V_WHL_FL	FL wheel speed	km/h	0 ... 260
V_WHL_FR	FR wheel speed	km/h	0 ... 260
V_WHL_REF	ESP reference speed	km/h	0 ... 260
A_STE	Steering angle	°	-200 ... 200
V_STW_LIMIT	Speed limit value	km/h	40 ... 120
FLAG_STW_OUT1	Steering wheel button state	#	0 ... 8
FLAG_STW_OUT2	Steering wheel button state	#	0 ... 8
FLAG_STW_OUT3	Steering wheel button state	#	0 ... 8
FLAG_FBX_F5	Fuse state 5	#	0 ... 8
FLAG_FBX_F4	Fuse state 4	#	0 ... 8
FLAG_FBX_F3	Fuse state 3	#	0 ... 8

FLAG_FBX_F2	Fuse state 2	#	0 ... 8
FLAG_FBX_F1	Fuse state 1	#	0 ... 8
I_FBX_MAIN	Main current	A	10 ... 40
I_FBX_TURNLIGHT	Turnlight current	A	0 ... 10
External Voltage	Battery Voltage	V	11 ... 14,5
Gear_Lever	POS_GBX_LEVER	number	0=Init, 5=D, 6=N, 7=R, 8=P, 10=Tip+, 11=Tip-, 12=S, 14=Tip Pos., 15=Failure
DSG Mode	POS_GBX	number	0=Init, 5=P, 6=R, 7=N, 8=D, 9=S, 13=TD, 14=TS, 15=Failure
Gear	GEAR	number	0=Init, 5=P, 6=R, 7=N, 8=D, 9=S, 13=TD, 14=TS, 15=Failure

GPS channels	Description	Unit
GPS_Speed	Speed	km/h
GPS_Nsat	Nº of satellites	#
GPS_LatACC	Lateral acceleration	G
GPS_LonACC	Longitudinal acceleration	G
GPS_Slope		°
GPS_Heading		°
GPS_Gyro		°/s
GPS_Altitude		m

The values shown in the following table are the standard approximate values at 20°C air temperature for main car control channels.

Channel measures	Idle speed	Values at Tair 20°C	Maximum value
P_TURBO	0 bar	2.35 bar **	>2.99bar
P_ENG_FUEL	4.1 bar	4.3 bar	6 bar
P_ENG_OIL	1.5 bar	3.6 bar	5 bar
T_ENG_AIR	40°C	42°C	>75°C
T_ENG_OIL	80°C	122°C	>147°C
T_ENG_WATER	90°C	95°C	>120°C
T_GBX_OIL	90°C	114°C	>138°C

3.4 Fusebox

The fusebox is an electronic box that controls the power supply to practically all devices. Internally, the thermal fuses reset automatically, so changing a fuse will never be necessary. In case of malfunction it has to be sent to SEAT Sport. It is also possible to check if a fuse has blown in the fusebox, so you will know if the current or signal was sent.

There are three ways to check the correct functioning:

- Live measures view in RaceStudio3.
- Checking the fusebox control channels in Race Studio Analysis.
- Checking the red LEDs on the fusebox.

If a malfunction is detected, it is necessary to control the corresponding wiring or the device.



Fuse box LED label

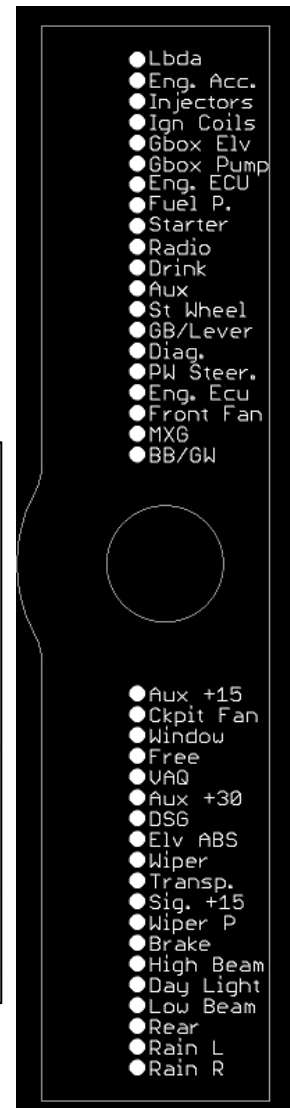

On the following table is shown the fuse analysis information:

- Channel name: There are 5 channels for analysis
- Bite number: Each flag channel controls 8 fuses.
- Data value: Is the value you can check on the data acquisition.

Channel name	Bit number	Data value	Description
FLAG_FBX_F5	bit8	-----8	Sadev pump
	bit7	-----7-	HR-ECU
	bit6	-----6--	HR-Fuel pump
	bit5	----5---	Starter
	bit4	---4----	Radio
	bit3	--3----	HR-Lambda
	bit2	-2-----	HR-Miscellaneous
FLAG_FBX_F4	bit1	1-----	HR-Injectors
	bit8	-----8	MR-ignition coils
	bit7	-----7-	Sadev-ELV

	bit6	----6--	Drink
	bit5	---5---	Switch Panel / Aux. Data connector
	bit4	---4---	Steering Wheel
	bit3	--3----	Gear Lever / GCU
	bit2	-2-----	Diagnosis Connector
	bit1	1-----	Power steering ECU
FLAG_FBX_F3	bit8	-----8	ECU
	bit7	-----7-	Front Fan
	bit6	----6--	MXG
	bit5	---5---	Blackbox / Gateway
	bit4	---4---	Differential
	bit3	--3----	+30 Aux. connector
FLAG_FBX_F2	bit2	-2-----	DSG
	bit1	1-----	ABS ELV
	bit8	-----8	Wiper
	bit7	-----7-	Turn light
	bit6	----6--	Diagnosis Connector / +15 Aux con.
	bit5	---5---	Cockpit fan
	bit4	---4---	Window
	bit3	--3----	not used
FLAG_FBX_F1	bit2	-2-----	Transponder
	bit1	1-----	+15 signal
	bit8	-----8	Wiper pump
	bit7	-----7-	Brake light
	bit6	----6--	High beam
	bit5	---5---	Day light
	bit4	---4---	Low beam
	bit3	--3----	Rear light
bit2	-2-----	Rain light left	
bit1	1-----	Rain light right	

Example: In the acquisition screenshot below, it's shown the channel "flag_FBX_1" in green the value is "7" when braking and 0 when no braking. On this case the information is that there is a problem on the brake light line.

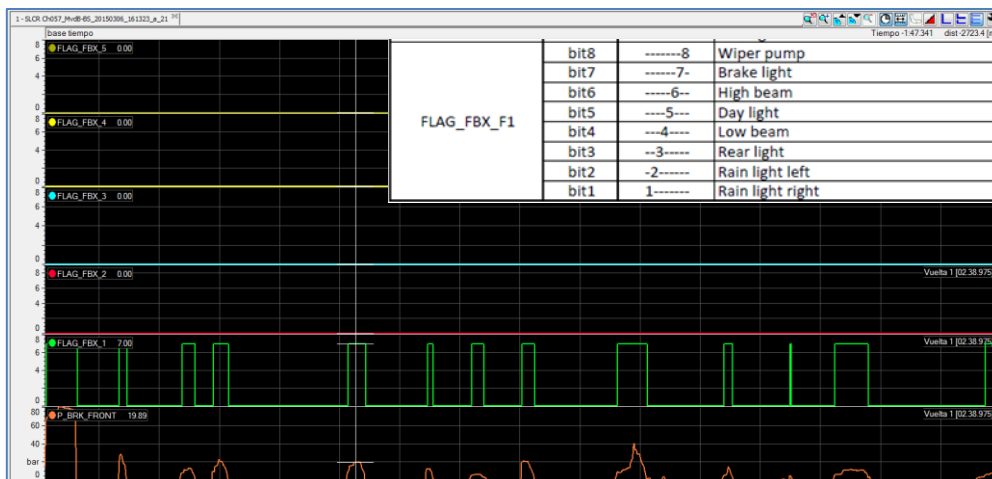

3.5 Fuel level display

All new SEAT Leon TCR cars have a fuel display to control the fuel remaining at the tank. It is tied to the roll cage in the rear right door area. The display has to be set after each refuelling. This setting is very important to get the correct fuel level because it is calculated by the fuel consumption sent from the engine ECU.

- There is a light sensor for automatic brightness trimming.
- Two sensitive zones below the four digits allow menu navigation.
- It is important not to touch the front panel when it is switching on due to the initial capacitance setting during start up.
- Also take special care wiping with hand the front panel if device is switched on.
- Electrostatics charge could affect the sensitive touch and set undesired actions.



Terminology

Following, the terminology description to understand future command tables:

- **Llp**: Left long push (>1s)
- **Rlp**: Right long push (>1s)
- **Lsp**: Left short push (<1s)
- **Rsp**: Right short push (<1s)
- **STout**: Short Timeout (1s)
- **LTout**: Long Timeout (8s)

Fuel level adjustment

This menu allows the following possibilities:

- Set fuel level to full tank value.
- Add/remove a fuel quantity to the actual value.
- Set an absolute quantity (litres without decimal).

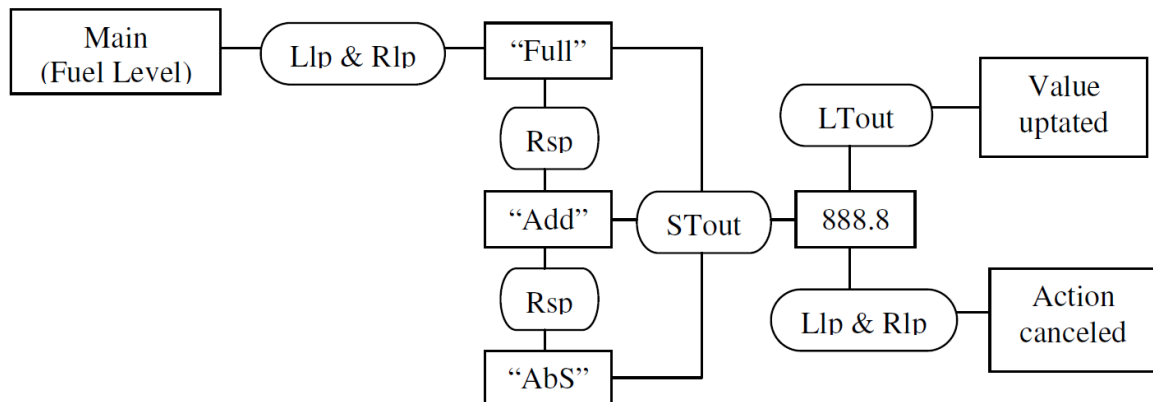

- When the value is shown (and blinking), a right short push increases this value litre by litre and a left short push decreases this value.
- Maintaining right/left long push, the value is increased/decreased 10 litres by 10 litres.

Set Full level value:

This menu allows setting the maximum tank level or predefined fuel level.

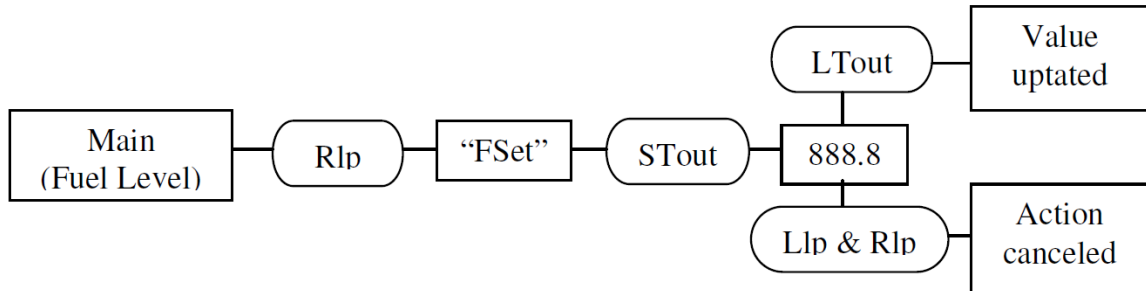

Brightness and bar graph set

It is possible to modify the brightness and bar graph settings.

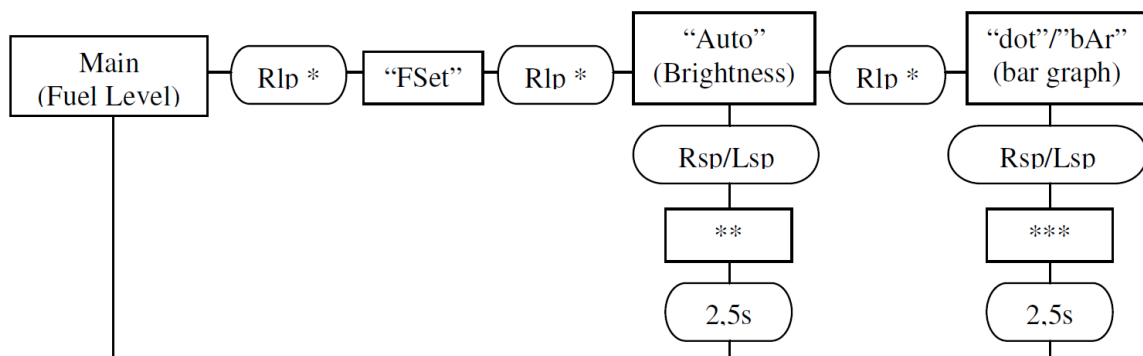

- * Long left push will scroll menu on the other side.
- ** "Auto" will adjust automatically the brightness. Else, use right / left touch to increase / decrease light level.
- *** "dot" mode will light on only one led on the bar graph. "bAr" mode will light on all leds beginning from the left side up to the level point. Note that the last led matches with the Full value set.

3.6 Auxiliary connectors

The main car wiring loom is prepared with some auxiliary connectors to make easier the connection of auxiliary devices.

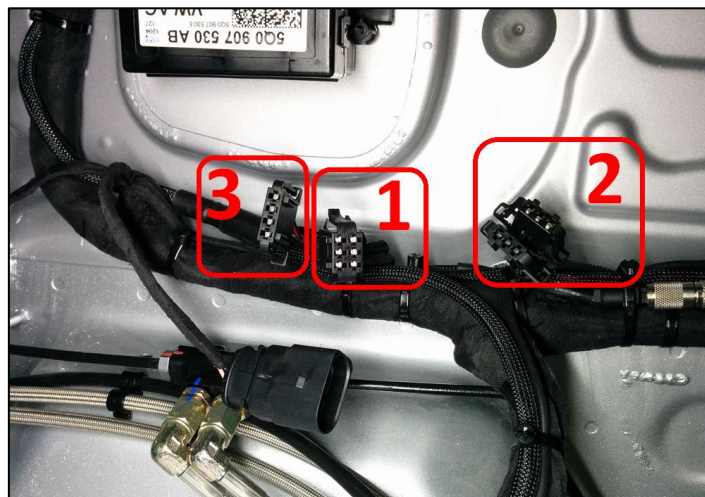

#1: Auxiliary power supply

This connector is placed in the driver cockpit above the central tunnel (front). It could be used for user requirements such as connecting the TCR scrutineering EVO4 logger.

Auxiliary power supply		
Matching connector		191 972 733
Pin-out		Terminal
1	+30 up to 8A	FS 2,8 x 0,8 (*)
2	GND	FS 2,8 x 0,8 (*)
3	CAN H traction	FS 2,8 x 0,8 (*)
4	CAN L traction	FS 2,8 x 0,8 (*)
5	CAN H chassis	FS 2,8 x 0,8 (*)
6	CAN L chassis	FS 2,8 x 0,8 (*)

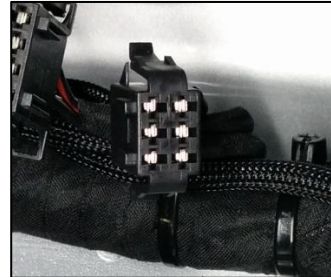

#2: Auxiliary analogic sensors

Two connectors are available connected to the dash logger.

Auxiliary analogic sensors		
Matching connector		191 972 713
Pin-out		Terminal
1	5v	FS 2,8 x 0,8 (*)
2	signal	FS 2,8 x 0,8 (*)
3	GND	FS 2,8 x 0,8 (*)



#3: Additional power supply

It can be used for any requirement.

Additional power supply		
Matching connector		1J0 972 714
Pin-out		Terminal
1	+30 up to 8A	FS 2,8 x 0,8 (*)
2	+15 up to 5A	FS 2,8 x 0,8 (*)
3	GND	FS 2,8 x 0,8 (*)
4	GND	FS 2,8 x 0,8 (*)



Radio and drink

Behind the driver seat there are two free connectors associated with the steering wheel module. Connecting here the radio and drinking systems, both can be handled through the steering wheel module.

Radio connector		
Matching connector		AMP Super-seal 4-way 282106-1
Pin-out		Terminal
1	PTT	183024-1 or 183036-1
2	PTT	183024-1 or 183036-1
3	+30 up to 8A	183024-1 or 183036-1
4	GND	183024-1 or 183036-1



Drink connector		
Matching connector		1J0 973 822
Pin-out		Terminal
1	up to 2.5A	
2	GND	

Power supply cut

There is a connector that gives power supply to the fusebox, so in case of disconnection cuts all devices power supply.

You can unplug it in case of transport or for a most safety disconnection in case of workshop big jobs.

See connector placement close to the fusebox main connectors on the picture beside.



Transponder

This auxiliary connector is placed next to the right front headlight. All TCR cars are provided without transponder.

Transponder		
Matching connector		357 972 762
	Pin-out	Terminal
1	12v	FS 2,8 x 0,8
2	GND	FS 2,8 x 0,8

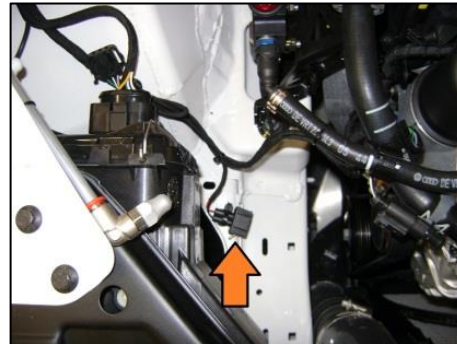

4.2 Steering rack centering

As the steering rack is electric, the steering angle sensor has to be electronically aligned with the wheels at the aligning time.

How to proceed to align the steering angle sensor:

It is necessary fix the steering wheel. To do it, you can use straps fixed between the roll cage and the steering wheel or other kind of standard tools.

The use of a rack centring stopper tool is not recommended because it is difficult to get the steering angle sensor at 0 deg. The most important is to obtain the toe alignment with the sensor at 0 deg.

Proceed as following:

- Switch on main and ignition switches.
- Turn left and right to get the steer angle signal initialized.
- Fix the steering wheel when the steer angle is 0 deg.
- Switch off the ignition and main.
- Proceed now with the alignment jobs.

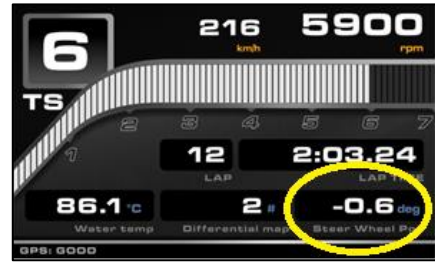

Note:

- With this process the steering angle signal will be 0 deg with the wheels aligned. This is very important for the steering assistance and for the electronic slip differential behaviour.

4.3 Suspension

	Front	Rear
Wheel ratio	1mm wheel / 0,9mm damper	1:1
Bilstein Damper travel	110mm	119mm

4.4 Front camber and toe adjustment

Underneath the front wishbone there is a bolt to control the adjustment movement. Unblock the four screws that are fixing the camber regulator plate and proceed to the adjustment.



Notes:

- After any intervention, fix the wishbone regulator plate bolts in the right tighten.
- Maintain the wishbone regulation plate clean and little oiled between plates.

Front regulation table (rough values):

Camber	Toe regulation	Wishbone regulation 1,5 turns = 10° camber
-5,8°	9,5 turns	12 turns
-5,5°	7 turns	8,3 turns
-5°	3,5 turns	4,5 turns
-4,5°	0	0
-4°	-3,5 turns	-4 turns
-3,8°	-6 turns	-7 turns

Note:

Take care with the maximum and minimum camber. Although physically the camber adjuster can reach higher values, it's not recommended due the drive shaft limitations.

4.5 Rear camber and toe adjustment

To reach the rear suspension set-up value is recommended to proceed as following:

1. Car ride height: put the ride height at your choice through damper/spring adjustments.
2. Camber: to change the camber is recommended to move the "boomerang" arm.
3. Toe: to change the toe enlarge or reduce the rear arm.
4. Check: Adjust a second time if necessary.



Notes:

- The rear camber regulation does not have relation with the toe movement, so it is possible to change rear camber without any toe movement.
- After the camber adjustment job, check that the ball-joint is placed in the middle of its housing.

Rear camber regulation table:

Camber	Arm regulation
-2°	1,5 turns
-2,5°	1 turns
-3°	0,5 turns
-3,5°	0
-4°	-0,5 turns
-4,5°	-1 turns
-5°	-1,5 turns

4.6 Dampers

Front Damper
2 – way adjustable in bump and rebound
Aluminium outer housing
Bump Stop 20mm

Front damper adjustment:



Upright height Adjuster
0mm (-10mm to +10mm)

FORCE ADJUSTMENT

Red Adjuster (Rebound)
Blue Adjuster (Bump - Compression)
Pos 1-soft to 10-hard.



Rebound (Red ---> Rebound)
Compression (Blue ---> Bump)

Rear Damper information
2 – way adjustable in bump and rebound
Aluminium outer housing

Rear damper adjustment:



FORCE ADJUSTAMENT

Red Adjuster (Rebound)
 Blue Adjuster (Bump - Compression)
 Pos 1-soft to 10-hard.



Rebound (Red ---> Rebound)
Compression (Blue ---> Bump)

To set up the car suspension, the following spring range can be used in the front and rear axle:

Measures	Nm	Remark
160-60-120	120	Front use recommended
160-60-110 (car delivery - front)	110	Front use recommended
160-60-100	100	Front use recommended
160-60-90 (car delivery - rear)	90	Rear use recommended
160-60-80	80	Rear use recommended
160-60-70	70	Rear use recommended

Range of the front and rear struts:

FRONT

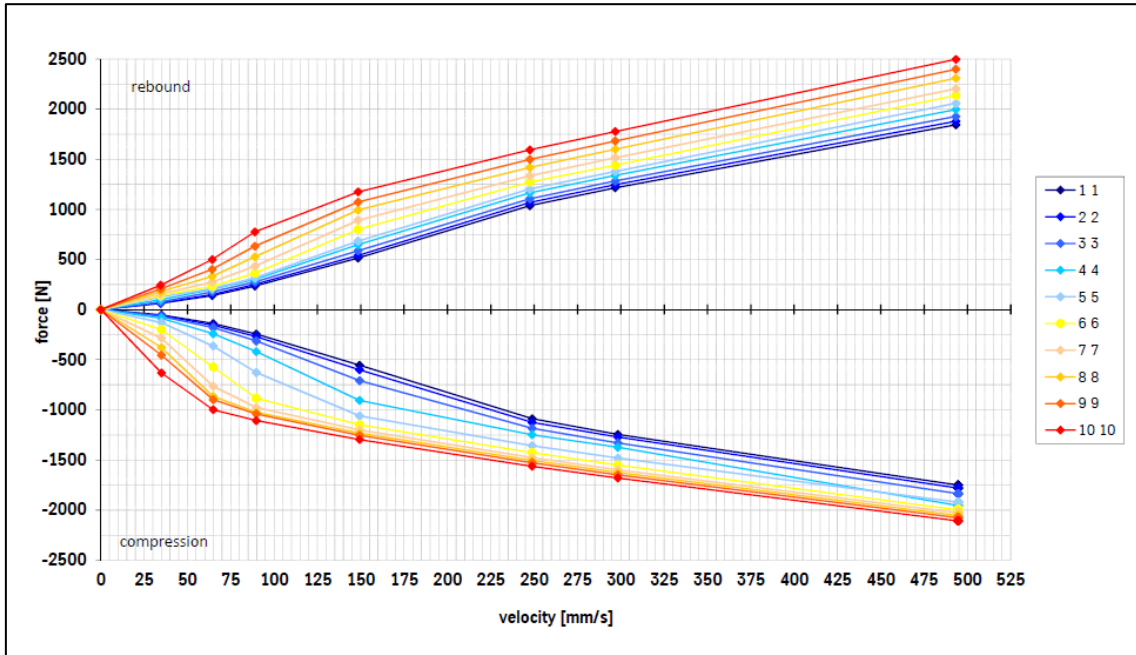

REAR

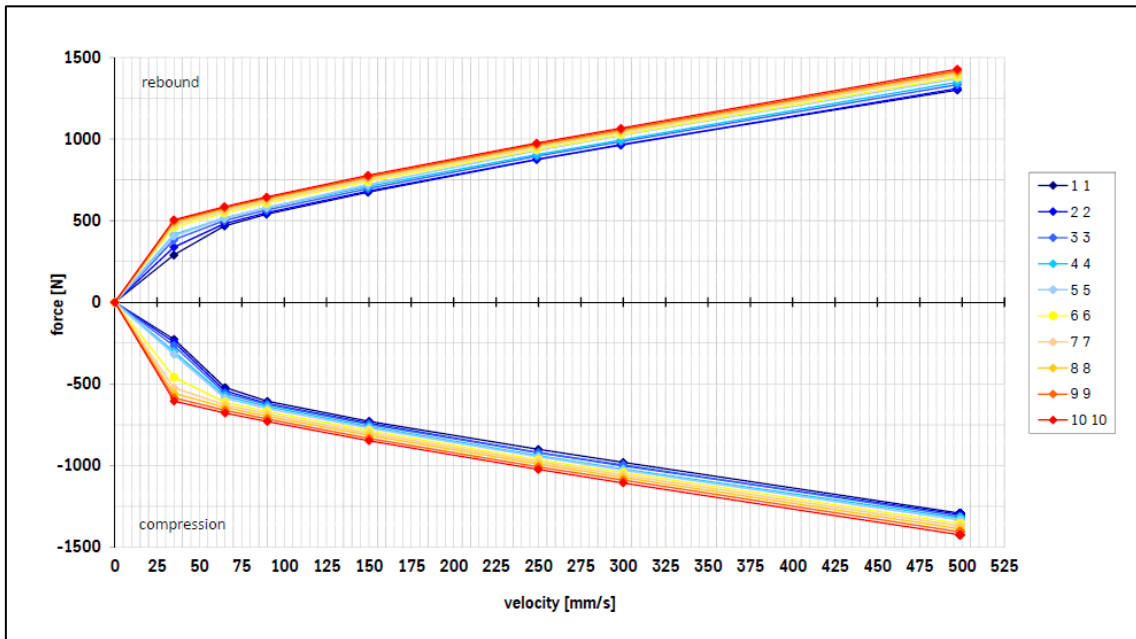

4.7 Antiroll bars

Two front anti roll bar available: 22x2 and 22x3. **Car delivery: 22x3.**

FRONT ARB		
OD (mm)	22	22
Thickness (mm)	2,0	3,0
Chassis Roll Stiffness from ARB		
Hard (Nm/°Chassis)	1548	2021
Mid (Nm/°Chassis)	991	1293
Soft (Nm/°Chassis)	688	898

Two rear anti roll bar available: 22x3 and 22x4. **Car delivery: 22x3.**

REAR ARB		
OD (mm)	22	22
Thickness (mm)	3,0	4,0
Chassis Roll Stiffness from ARB		
Hard (Nm/°Chassis)	1252	1454
Mid (Nm/°Chassis)	1061	1232
Soft (Nm/°Chassis)	898	1043

4.8 Kinematics

FRONT

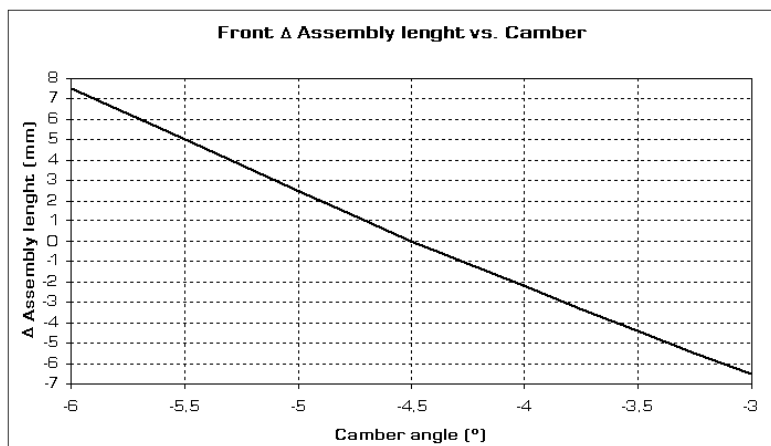
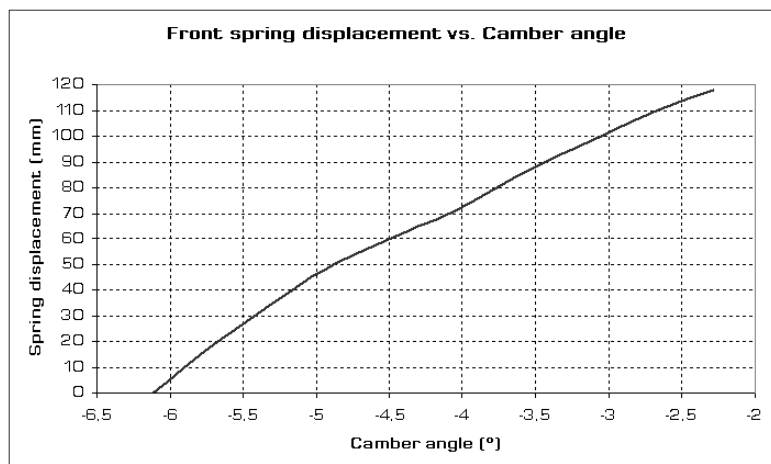
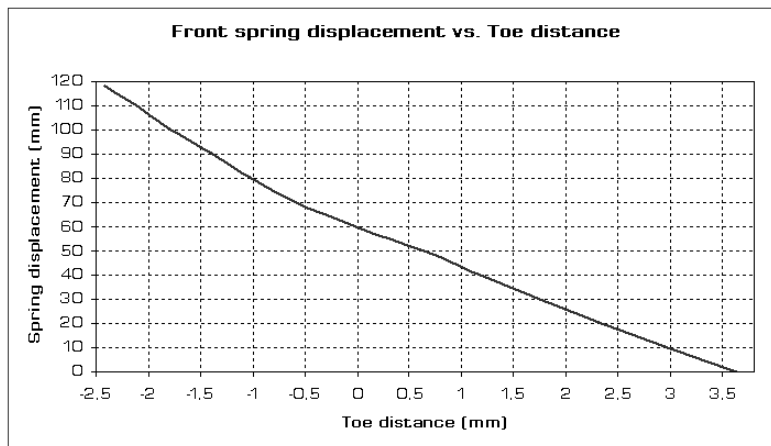

REAR

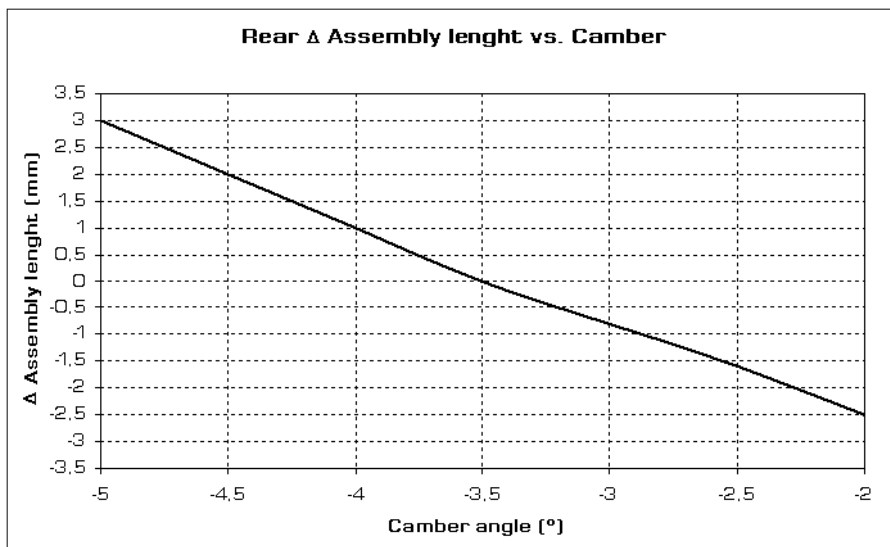
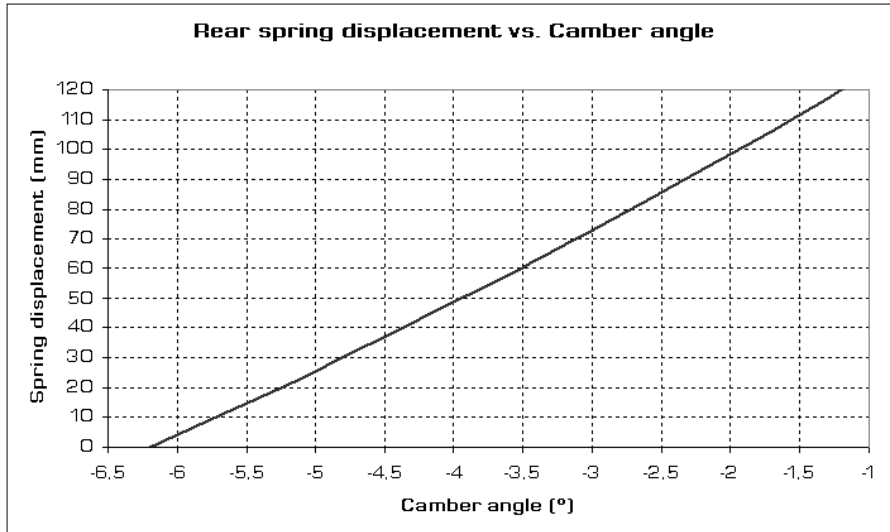
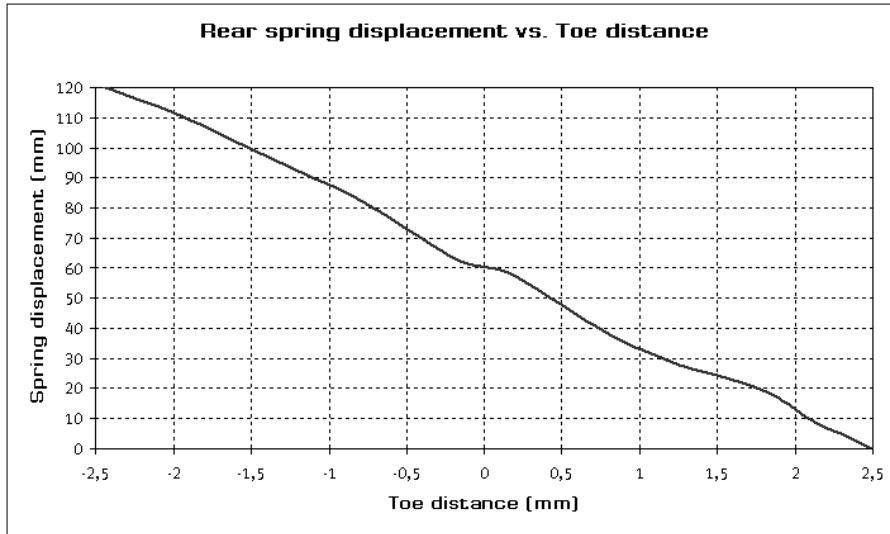

4.9 Brakes

Available brake pumps range.

MASTER CILINDER	Push Rod	Remarks
AP 15 MM	PRT 110	
AP 15.9 MM	PRT 110	
AP 16.8 MM	PRT 110	
AP 17.8 MM	PRT 110	
AP 19,1 MM	PRT 110	SEAT Sport car delivery
AP 20,6 MM	PRT 110	
AP 22,2 MM	PRT 110	SEAT Sport car delivery
AP 23,8 MM	PRT 110	

- It is not advisable to use more than two pump diameters difference between front and rear.
- If the master cylinders are replaced, take care on the correct installation and functioning of the brake balance bar. The following link shows how to assembly correctly:
<https://tiltonracing.com/wp-content/uploads/2013/07/98-1250-600-Series-Balance-Bars.pdf>
- On the dashboard screen it is shown the front/rear pressure and the balance percentage. The recommended percentage is 60% front (car delivery).
- Brake balance channel: $\frac{P_BRK_FRONT}{P_BRK_FRONT + P_BRK_REAR} * 100$

Brake balance bar (on the pedal box)



Balance bar remote control



4.10 Aero

All aerodynamic parts have to be in good conditions. Check periodically the fixations.

Rear wing:

- The rear wing has extensive regulation. Zero is a standard setting for the car.
- Wing angle – 5° has considerable influence on the rear down force.
- Wing angle – 10° has big influence on the rear down force as well as speed.
- Lateral plates are individually adjustable. (2015 lateral plates)

Front splitter:

- Check periodically the fixations. Have to be in good conditions.
- Check the front splitter angle that has to be at 0° when pitch is 0°.

Pitch:

- Measure the pitch angle on the body shell over the door sill.

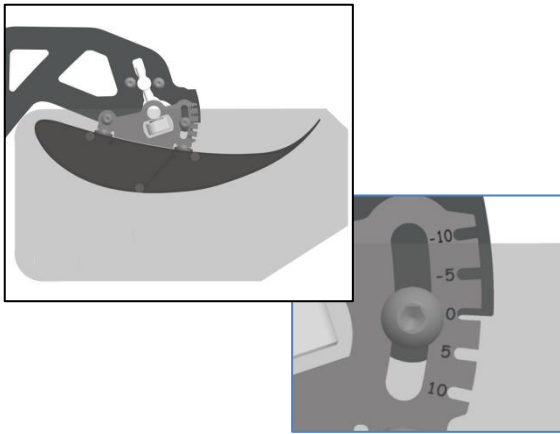

5 WORKSHOP MANINTENANCE

5.1 FIRST ROLLOUT

SEAT Sport checks all the cars in a roll-out before customer delivery. This roll-out consists in:

- 5 circuit laps.
- High speed in a long straight.
- Start rev limiter checking simulating a standing start.
- Speed limiter function checking.
- After the roll-out, SEAT Sport engineers check the data acquisition and all car functions.

Note:

- Although SEAT Sport does a roll-out, it is strongly recommended to carry out a suspension check before first customer roll-out and after the first practice. Pay special attention to sub-frame, power train, engine brackets, fixations, etc.

5.2 Check list

After any rebuild or main job is recommend to carry out a check list. It's possible do it with a lap top with RaceStudio3 program or directly to the car display.

		CHECK LIST with ENGINE STOPED	OK
ENGINE	Oil level	On the dipstick mark / Toil > 70°C	
	Cooling Water	On the bottle mark	
BRAKE	Brake fluid	On the bottle mark	
		CHECK STEERING WHEEL FUNTIONS	OK
FUNCTIONS	Rain Lights		
	Driver Fan		
	Page Change		
	Safety Brake Signal		
	Diff Map Change		
	Windscreen Water		
	Wiper		
	High Beam		
AIM on-line	conditions	CHECK LIST with ENGINE IN IDLE SPEED	Value OK
ENGINE	Water Temp	87°C / 92°C (thermostat cicle)	
	Fan	Active at 92°C	
	P oil (WT<25°C)	4 bar	
	P oil (WT>25°C)	2,5 bar	
	P fuel low	> 4,1 bar	
	Alternator	> 13,5 volts	
	Boost Press	0,3 bar @ 2500rpm	
	Speed limiter	Gear 4 @ 60km/h	
GEARBOX	Tipp TS	Changing gears / check SWM signal -- +	
	N° gear display		
DIFF	Activar Pump		
FUSEBOX	FLAG_FBX_1	0	
	FLAG_FBX_2	0	
	FLAG_FBX_3	0	
	FLAG_FBX_4	0	
	FLAG_FBX_5	0	

5.3 Vehicle & parts identification

V.I.N. (Vehicle Identification Number) is welded on the roll cage

Nº: **VSSMK35F4ESSPXXXX**



Engine identifications.

Nº: **CJX xxxxxxx**



Distribution seal

detail



Turbo seal detail



Gear box identification.

Nº: **C0xx**



Slip differential identification

Nº **D0xx**

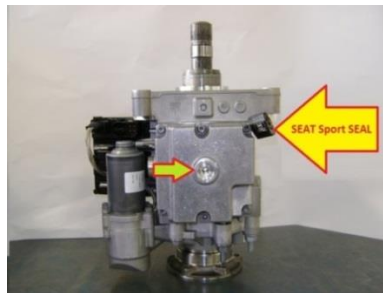

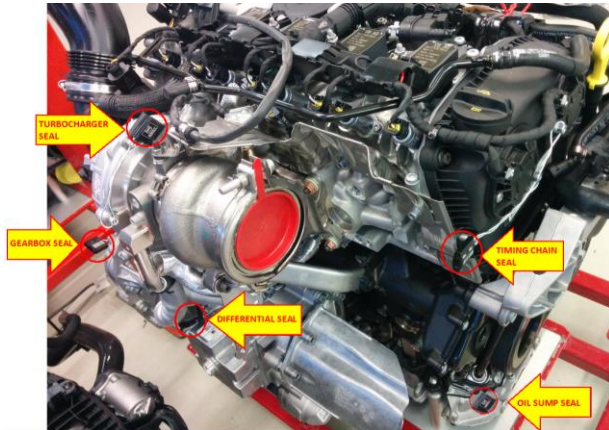

General ENGINE seals view:
view

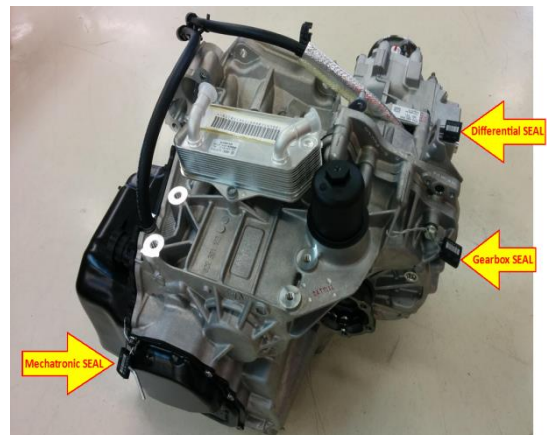

General GEARBOX – DIFF seals



5.4 Fluids information

Fluids	From	Remarks	Quantity
Engine		CASTROL EDGE 5W-30 VN0000053000	Substitution with filter change 5,7 lts
Gear box	VW-Audi	_G052182A2	Substitution 5,2 lts Mechatronic 3 – 4 lts
Electronic Slip Differential	VW	_G060175A2	Unit 0,7 lts Substitution 0,5 lts
Drive shaft	VW-Audi	VN0000040401	100 gr
Coolant		VN0000060400	5 lts
Brake fluid		CASTROL SRF VN0000062400	—
Fuel	PANTA (Eurocup SEAT)	NS 102 Ron	
Windscreen cleaner	Free		0.....2 lts

Notes:

- SEAT Leon Cup Racer: Use only the fuel distributed on the race track.
- It's forbidden any product addition on the fuel.
- Fuel: standard fuel 98 oct. from petrol stations to 102oct.
- Is recommended not to mixt fuels, could contaminate one from the other.
- Gearbox and Slip differential are supplied with the right level. It's not necessary any level control if there aren't leakages.

5.5 Engine service

Control routine before start to run:

- Check the oil level: With the oil temperature up to 70°C, stop the engine and wait 2 minutes, then you can check the oil dipstick. The oil level must be at the top of the marked zone on the dipstick.
- Check the water level before start.
- With the engine running, check there isn't any oil, water or fuel leakage.
- Check the fan functionality. Operating range 92°C to 87°C.

Maintenance routine:

- Change the engine oil and oil filter at the indicated mileage.
- Engine spare parts must be from VW group or SEAT Sport original parts, detailed on the Leon Cup Racer parts catalogue.
- Use always fluids detailed on the Leon Cup Racer parts catalogue.
- Clean and check the air filter in each event. At the urban circuits is recommended clean or replace more frequently. It's also recommended to have two or three air filters and replace during the weekend. Change is strongly recommended in case of rain.
- Check that the alternator belt is clean and there aren't small stones inside the Poly-V.
- Often clean the radiator and intercooler panel.
- If any doubt, contact to the SEAT Sport service.
- Check the SEAT Sport seal is in good condition.

Parts subject to frequent service:

Engine	Torque	Remarks
Oil drain plug	By hand	Change the plastic cap
Oil filter plastic cover	50 Nm	
Oil filter	<<	Moisten the "O" ring
Spark plug	28 Nm	Use original parts only

For detailed parts substitution information download yourself the "Workshop Manual" from our web, "www.seat-sport.com".

5.6 Air filter





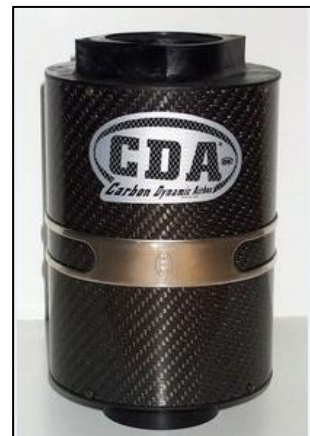

Air filter	Torque	Remarks
Air filter substitution	By hand	4 small bolts over plastic. Be careful.
Air filter clean		1) Clean the cotton air filter following the procedure showed. 2) DO NOT use compressed air or high-pressure air to clean. Use only the recommended oil for cotton filters.

Notes:

- The air filter type and measurements are identified on the "Technical Regulations". It's not allowed any modification or change.
- The air filter clean and properly oiled is critical for the turbo charger life. **It is strongly recommended to follow the cleaning procedure as well as the timing.**
- After using in rain conditions is recommended the cleaning or replacement.



Air filter std. clean procedure

	<p>1</p> <p>Remove the larger dirt by shaking or tapping your filter gently onto a clean surface. DO NOT use compressed air which may damage the filtering element.</p>
	<p>3</p> <p>Wash your filter in cold water. Rinse well ensuring that dirt does not enter the filter pleats. DO NOT use high-pressure water.</p>
	<p>5</p> <p>Remove the original top from the regenerating fluid bottle. Make a small hole in the spout dispenser and screw onto the bottle. For correct oiling we recommend passing the regenerating fluid twice over every pleat on both sides of the filter.</p>
	<p>7</p> <p>Allow the oil to absorb on a level surface for around 30 minutes. Remove any excess oil on the rubber and check that the filtering element is homogeneously red (Picture 7). If not, repeat the oiling process described previously. After oiling the filter is ready to be reinstalled.</p>
	<p>2</p> <p>Distribute the BMC detergent on the filter. Allow to absorb for about 10 minutes. DO NOT use caustic products such as petrol or oil. USE ONLY BMC DETERGENT.</p>
	<p>4</p> <p>Let in a accurate proper way your filter dry naturally away from heat sources on absorbent paper or on a clean cloth. DO NOT use a hair-dryer or compressed air.</p>
	<p>6</p> <p>The oiling procedure using the aerosol spray. Hold the spray 15 cm from the filter and spray the complete surface. Repeat the operation on both sides of the filter.</p>

5.7 Gearbox

Control routine before start:

- Check that there isn't any oil leakage.
- Operating range 70°C to 135°C.
- Do not load the engine until the gear box temperature its upper to 70°C (control on the display).

Routine maintenance:

- Change the gearbox oil and filter in the indicated mileage (see mileage table).
- Oil filter, as well as the rest of the gearbox spare parts, must be from VW group or SEAT Sport original parts, detailed on the Leon Cup Racer parts catalogue.
- If there is not any oil leakage it is not necessary any level control (paragraph 6).
- Check that the SEAT Sport seals are in good conditions.

How to change the Gearbox oil:

- With the gearbox oil temperature below 50°C, the lever in position P, the vehicle on a level and the engine stopped, remove the oil drain plug and the overflow pipe located inside.
- Wait until all the oil runs out, more or less 5 litres, and screw the overflow pipe again (3Nm). Change also the gearbox oil filter.
- Fill 5,5 litres of new oil and hand-tight the oil drain plug. Seat Sport recommends using the adapter for the gearbox oil filling (VAS 6262A). If not fill it from the oil filter housing (much slower).
- Start the engine. Depress brake pedal and select each selector lever position for 3 seconds. Then go back to P. Do not switch off the engine.
- With the engine running at idle speed and the gearbox oil between 35 and 45°C, remove the oil drain plug again and let the surplus oil drain out. When it begins only to drip, install the oil drain plug with new seal (45Nm).

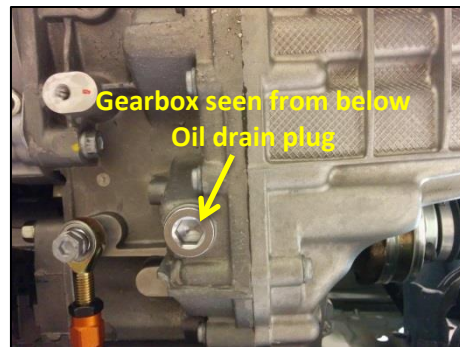

Note:

- If when doing the level after removing the oil drain plug no oil drains out: stop the engine, add 0,5 litres more and repeat the process from running the gearbox in all selector lever positions.

How to adjust the gear and selector levers:

- Unscrew the selector lever bolt (see picture).
- Put the lever in P.
- Turn the gearbox selector lever backwards.
- Screw the selector lever bolt.

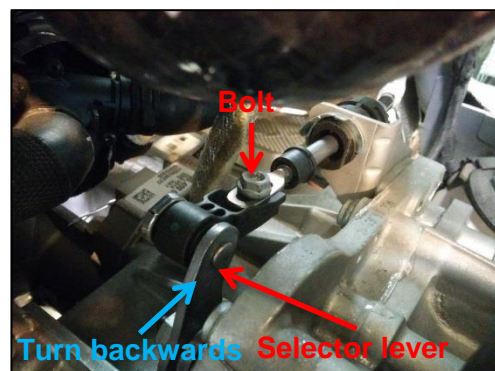

5.8 VAQ – Electronics differential

Routine maintenance:

- Change the FDX oil in the indicated mileage. (See mileage table). Use only the recommended oil.
- If there isn't any oil leakage there is not necessary any level control.
- Send to SEAT Sport for revision when recommended service mileage is reached.

Slip differential jobs	Torque	Remarks
FDX oil level check cap	15 Nm	Change every time

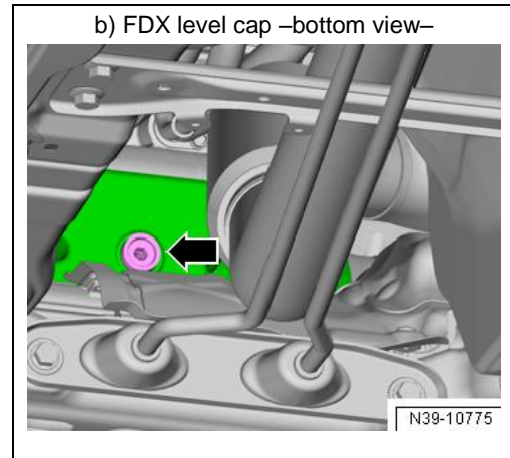
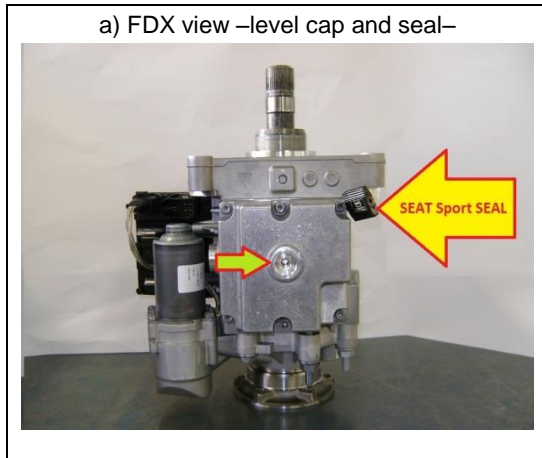

How to change the FDX oil:

To replace the oil is recommended to disassemble the unit from the car. Open the cap bellow, drain it and close it again. Measure the quantity and put in the same quantity. If you are doing it mounted on the car, take care, 100 ml will not be possible to add from the cap (shown in the picture b) above). The last 100 ml have to be added through the venting pipe on top.

Notes:

- In case of disassembling the unit from the car, the unit must be positioned in vertical position, as it is shown in the picture, to avoid any oil leakage.

5.9 Fuel tank

The new 100l FIA FT3 fuel tank is working with one unique fuel pump coming from series and a complex Venturi hoses system. The pump is controlled through a series PWM fuel control module.

Fuel tank features	Description
Fuel tank type	FIA FT3 homologated fuel tank
Capacity	104 l ±2%
Minimum fuel level before engine fault	Less than 1 litre
Ventilation valve	FIA homologated roll-over, ventilation and 200 mbar pressure regulator valve
Refuelling	Safety FIA plug

Refuelling tool:

The fuel tank is served with a FIA approved fast coupling plug. The socket is the necessary connector-tool that has to be used for refuelling the tank. This part is available on the 2016 Parts Catalogue.



Refuelling process:

1. Prepare an external bottle with the desired quantity of fuel. It is recommended using a ground cable on the bottle to avoid static electrical discharges.
2. Connect the refuelling hose with the socket to the fuel tank plug (#1 on the picture below) and the fuel will flow inside.
3. Set the fuel level display with the fuel amount inside the tank. This value will be shown on the display. For more info about the fuel level display check point 3.5 on this User Manual.
4. Pay special attention to the fuel amount refuelled and be accurate when setting the fuel level display, the driver will not feel any power engine drop until there is less than one litre inside the tank. Never try one lap more after a power drop.

Fuel tank placed on the car

1. Fuel tank refill plug
2. Fuel pump connector
3. Battery supply
4. Fuel level display



Fuel draining tools:

On the car there is a FIA fast coupling plug placed on the engine bay fuel line ready for draining use.



There are two tools available on the 2016 Parts Catalogue. First, there is a contra-connector D-6 socket available to connect in the fuel line plug that opens the circuit for draining.



Secondly, SEAT Sport has developed a new electronic tool to activate the fuel tank pump permanently or with the new automatic function.



Fuel draining process:

1. Connect the electric tool on the fuel pump connector (#2 on the picture above), placed on the fuel tank, and the power supply on the auxiliary battery connector (#3).
2. Connect the fuel soaked connector on the engine bay.
3. Switch on the electric tool in automatic or manual mode. If the automatic mode is selected the tool will stop the draining process when it detects that there is no more fuel inside the tank.

Flow fuel pump filter cleaning process:

1. Drain out the fuel tank completely.
2. Open the fuel tank right side cover (picture 1).
3. Raise a little bit the plate and disconnect the pipes and wirings.
4. Turn the fastening and pull up the pump from the reservoir (picture 2). Pull hard the black hoses to disconnect them from the main pump. Don't forget clipping them hard again when mounting.
5. Remove the green mesh filter and clean it (picture 3).

In case you need to take out the reservoir, unclip the green plastic brackets and pull-up the reservoir (picture 4).

Picture 1



Picture 2

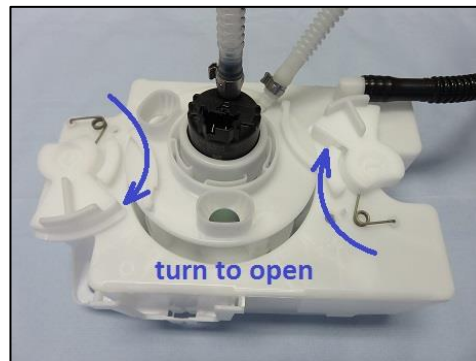

Picture 3

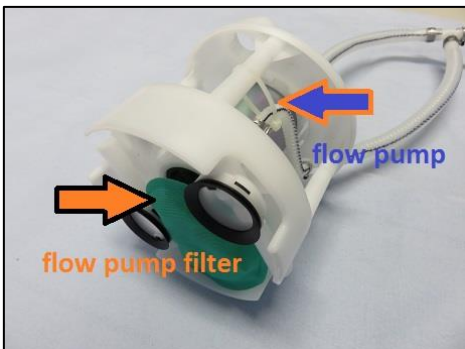

Picture 4

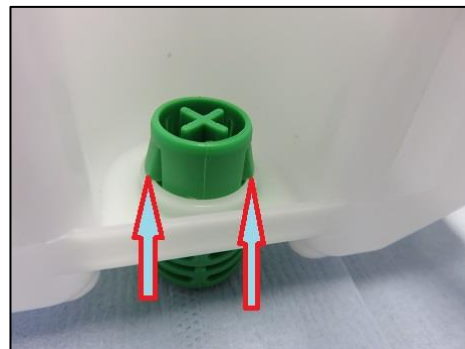

Engine fuel filter replacing process:

The engine fuel filter is placed inside the fuel cell. The part is fixed by a tie-wrap and fuel pipes are connected by fast couplings.

1. Drain out the fuel tank completely.
2. Open the right cover of the fuel tank.
3. Separate the inner foam and introduce the hands inside to cut the tie-wrap and disconnect the fuel pipes.

Schematic view of the engine fuel filter placement:

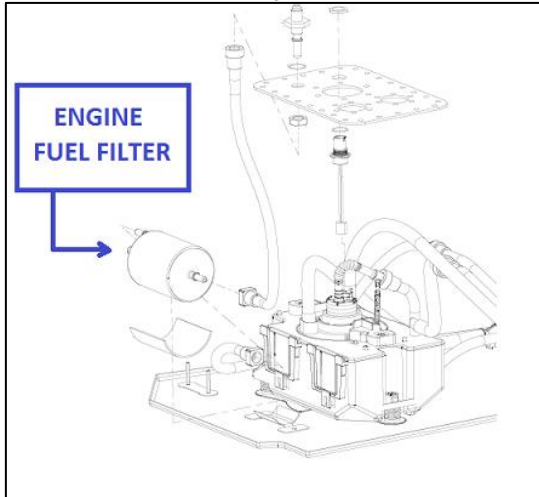

Engine fuel filter placement inside the fuel cell:

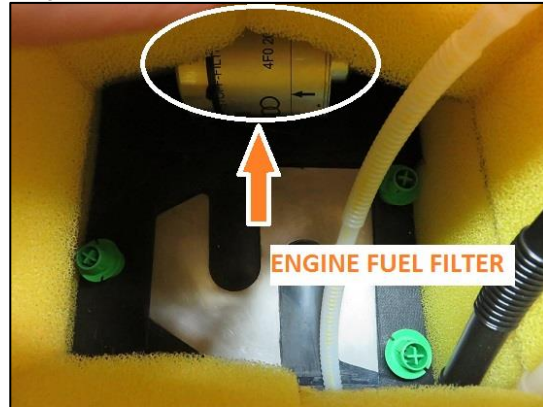

5.10 Airjacks

The SEAT Leon Cup Racer TCR is provided with an airjack system. The connector is placed on the rear right side (inside the standard refuelling cover).

Airjack plug on the car:



Airlance view:

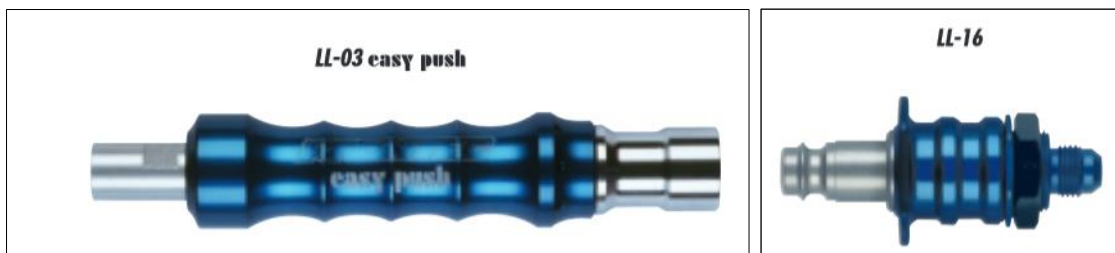

Notes:

- Maximum air pressure is 30 bar.
- Inlet thread of the airlance is M16x1.5

- **IMPORTANT:** never work under a vehicle supported only by airjacks unless safety props are fitted.
- Do not use 'U' bolt type clamps as distortion of the body will cause the airjack to stick. Do not loosen or remove adaptor. Jacks must be vertical during operation. Mounting brackets or clamps to be fitted to threaded section of body only.
- Do not use petrol or paraffin for cleaning the airjacks as this will damage the rubber seals. Use an alcohol based cleaning fluid as Methylated Spirit. Use only silicone spray or silicone grease when internal lubrication is necessary.

6 PARTS MILEAGE

ENGINE	Inspection	Service	Change	Remark
Engine		7.000	12.000	SEAT Sport service
Spark plug			1.000	Use original parts only
Engine oil			1.000	Use recommended oil only
Oil filter			1.000	Use original parts only
Cotton air filter	Once per event	Once per event	season	2 units rolling change adv.
Poly-V belt	Once per event		1.000	

TRANSMISSION	Inspection	Service / km	Change	Remark
Gearbox		7.000	12.000	SEAT Sport service
Oil gear box			4.000	Use original parts only
Gearbox oil filter			4.000	Use original parts only
FDX (slip differential)		7.000	12.000	SEAT Sport service
FDX pump			4.000	Replace at this mileage
Oil FDX			4.000	Use recommended oil only
Drive shaft	Once per event	7.000	12.000	

Fuel tank	inspection	Service / km	Change	Remark
Flow pump filter	1.000			First inspection 150 km
Engine fuel filter			4.000	Use original parts only

FRONT AXLE	Inspection	Service / km	Change	Remark
Front dampers		4.000 / 1 year	8.000	Seat Sport service
Ball joints	Once per event		5.000	Always check tolerance
Steering rod inner joint	Once per event		5.000	Always check tolerance
Steering rack			15.000	
Steering handle	Once per event		4.000	Inspect cracks
Wheel hub	Once per event		10.000	Change when noise
Front Discs	Once per event		1.500	Change when cracks
Disc bells			5.000	Check float in disc
Brake balance bar	Once per event	4.000		

REAR AXLE	inspection	Service / km	Change	Remark
Rear dampers		4.000 / 1 year	8.000	Seat Sport service
Ball joints	Once per event		5.000	Always check tolerance
Wheel hub	Once per event		10.000	Change when noise
Rear discs			3.000	
Wheel nuts			3.000	

SECURITY PARTS	Service / km	Change	Remark
Extinguisher	5 years	7 years	SEAT Sport or OMP service
Bucket		5 years	
Safety Belts		5 years	
Fuel cell	5 years	7 year	

7 SAFETY

SAFETY	Remarks	Images
AIR JACK	3 Air Jacks on the car Max press 30 bar <u>Safety:</u> Safety Props: For any job under the car Use ALWAYS the air jack Safety Props. (x3)	
EXTINGUISHER	Material: Aluminium Weight: 6.2 kg Activation: Electric Use: Cockpit and engine bay <u>Safety:</u> Check the inner press bottle. Have to be in the green area. Fire extinguisher system: Check always that the 9v inner battery is in good conditions. Do not forget to put the toggle in "on" when car is running.	 
BACKET	FIA Homologated 8855 – 1999 Gel coated fiberglass shell W side fixing points HANS Compatible <u>Safety:</u> Check the homologation label "expiry date" period. Check ALWAYS the fixations Change if big crash.	
SAFETY BELT	<u>Safety:</u> Check always the fixations are well fixed Check the homologation label "expiry date" period... Check always the driver is strongly fixed.	