



LEON CUP RACER



2015

MXG DASH LOGGER

User guide



MXG Dash Logger

USER GUIDE



AiM Srl.
Via Cavalcanti, 8
20063 Cernusco S/N (MI)
Italia
Tel. (+39) 02.9290571

www.aim-sportline.com

Made in Italy



MXG Dash Logger

- 04 1. INTRODUCTION
- 06 2. WHAT IS IN THE KIT
- 08 3. LAYOUT AND PUSHBUTTONS
- 10 4. GEAR FLASHES AND ALARM LEDS
- 11 5. ECU CONNECTION
- 12 6. RPM
 - 12 6.1 RPM FROM ECU
 - 12 6.2 RPM VIA A 5-50 V SQUARE WAVE SIGNAL OR COIL (150-400 V)
- 14 7. SPEED CHANNEL
- 16 8. ANALOG INPUTS
- 17 9. DIGITAL OUTPUTS
- 18 10. RACESTUDIO3 SOFTWARE.
 - 19 10.1 CONFIGURATION
 - 21 10.1.1 DISPLAY CONFIGURATION
 - 22 10.1.2 CHANNELS CONFIGURATION
 - 23 10.1.3 ECU STREAM CONFIGURATION
 - 23 10.1.4 ALARM LEDS, DIGITAL OUTPUT AND SHIFT LIGHTS CONFIGURATION
 - 26 10.1.5 MODIFY OR DELETE AN EXISTING CONFIGURATION
 - 27 10.2 CONNECT YOUR MXG TO A PC
 - 27 10.2.1 CONFIGURATION TRANSMISSION
 - 28 10.2.2 ON LINE VIEW AND CALIBRATION
 - 29 10.2.3 DATA DOWNLOAD
 - 30 11. GPS
 - 30 11.1 TRACK MANAGER FEATURE
 - 32 11.2 FILTERS IN TRACK DATA BASE MANAGEMENT
 - 34 11.3 HOW TO ADD A NEW TRACK TO THE PC DATABASE
 - 36 11.4 HOW TO MODIFY TRACK DATA IN THE PC DATABASE
 - 37 11.5 HOW TO READ, WRITE AND DELETE TRACKS
- 39 12. EXPANSION
- 40 13. MXG PINOUT
- 42 14. TECHNICAL DRAWINGS



Thanks.

Dear Customer,

First, we would like to thank you for choosing the MXG dash logger as the tool for improving your racing-craft setup and on-track performance.

The MXG, with its extra wide 7" TFT display, advanced expansion and sampling capabilities, gives you the flexibility for reviewing at your data in your preferred way and recording them from a variety of sensors and sources.

Please, before digging into your new data system, keep in mind that we are constantly working on bettering our software and firmware.

So, please, be sure to check our website periodically for any updates.

www.aim-sportline.com



What is MXG?

MXG is a color, high-contrast, high-brilliance 7" TFT dash logger developed for race car installations. It is fully customer configurable.

Which data does it manage?

Data come from a wide range of sources, including your vehicle ECU, the internal accelerometers and gyro, the GPS module included in the kit, the analog/digital inputs, the external expansions as well as predefined math channels.

How many pages does it show?

You can define up to eight different fully customizable pages.

Is it possible to configure the pages?

You can choose among a wide library of page styles, defining the data to be shown. Also, end of scales and units of measure can be easily configured using the RaceStudio3 software included in the kit.

How do alarm LEDs work?

You can configure alarm LEDs choosing color, blinking frequency and defining the logic for turning them on or off.

What is possible with WiFi?

You can use a WiFi connection for transmitting the data of your test, sending data online and for configuring the system.

Are the data recorded by MXG compatible with the old MXL and EVO4 data?

Yes, MXL used to produce data in DRK format. MXG offers an improved data management and produces XRK format that only RaceStudio3 can read.

Nevertheless, the last releases of RaceStudio2 can detect XRK files and transform them into old DRK format files, compatible with MXL1 and EVO4 files.

What is the difference between the old DRK format and new XRK?

XRK, taking advantage from GPS technology, associates absolute time (from 1-1-1970) and GPS position to every data with the precision of 1 millisecond. In this way, it is possible to better compare different laps, and different tests.

What about RaceStudio3? What are the differences between the old DRK format and new XRK?

RaceStudio3 is the very new software for managing configuration, data download and data analysis for all the future AiM systems. It is going to substitute RaceStudio2, which has accompanied us for almost 15 years. Based on a totally new and much more flexible architecture, it is a work in progress; some features still have to be

developed, so they are actually shared with RaceStudio2.

We are going to upgrade it very often, so, please, don't forget to check our web site at www.aim-sportline.com.



2. What is in the kit

The MXG kit includes:

MXG dash logger



Harness



GPS05 module



Software



MXG Dash Logger

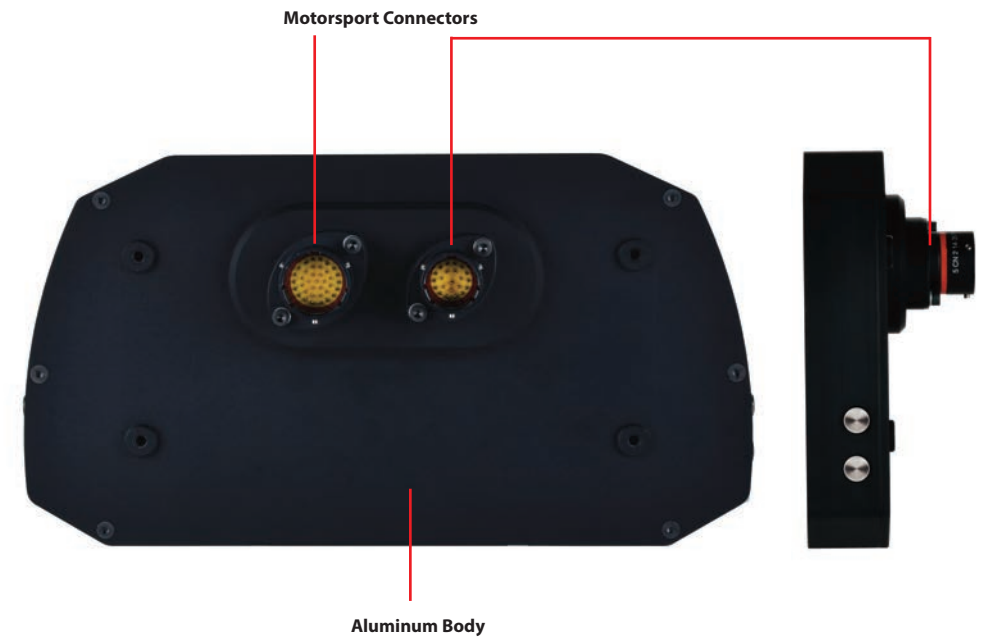
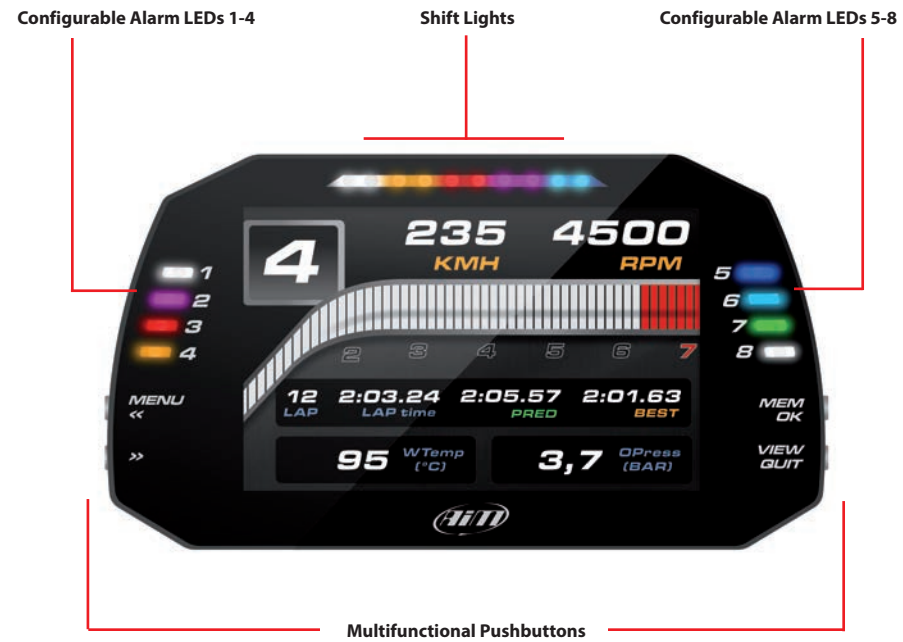

4. Gear Flashes and Alarm LEDs

1

MXG features 10 RGB gear flash LEDs that can be freely configured in a very flexible way. For every LED, you can define the RPM

value at which to turn it on and the colour. You can also define different RPM values per every gear number.

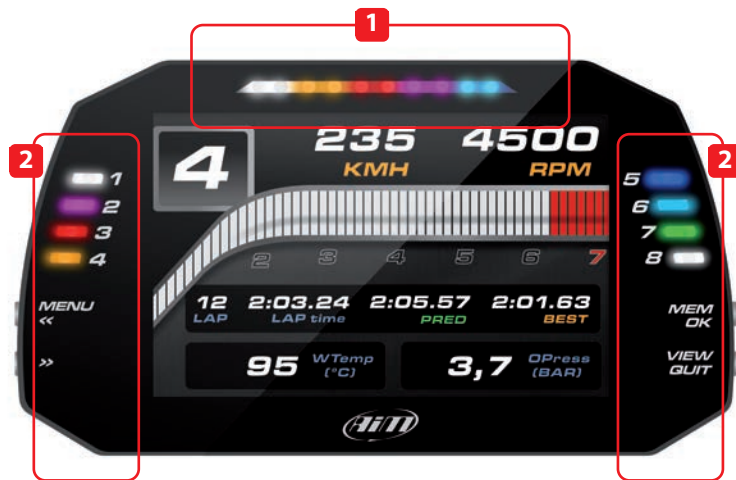

2

MXG also has 8 different alarm LEDs that you can configure in order to turn them on or off depending on the value of the analog or digital inputs, ECU values, expansion values, GPS information or math channels.

You can configure them in order to turn them off when the condition disappears, when you push a pushbutton, when the test is finished or when the data are downloaded after the test.

You can associate an alarm LED, a message and a digital output with every event.

Please, read section 10.1.4 in order to see how to manage gear flashes and alarm LEDs.

5. ECU connection

MXG can acquire data from the ECU of your vehicle.

The list of the ECU protocols available is published on our site:
<http://www.aim-sportline.com/eng/download/ecu-connections.htm>

This list includes approximately 700 different protocols and is constantly updated with new protocols and upgrades published every week.

When possible, documents explaining how to configure your ECU to ensure compatibility between the data flow transmitted are available, too.

From the hardware point of view, MXG is compatible with all currently available connections: CAN, RS232 or line K.

The steps to manage the data coming from the ECU are the following:

1. Determine which hardware connection is available for your ECU.
2. Read the documentation about your ECU at www.aim-sportline.com and identify the name of the proper software driver to be specified.
3. Using Race Studio 3, configure MXG setting that software driver with the menu shown here down, that appears when you create a new configuration.



The ECU to be selected has to be declared. When using the configuration software **RaceStudio3**, you create a new configuration of your MXG.

The steps are explained in section 10.1.

6. RPM

MXG can get the RPM signal in the following ways:

- From ECU
- Through a square wave signal (from 5 to 50 V)
- From the low voltage (from 150 to 400 V) of the coil

6.1 RPM from ECU

To get RPM from the ECU please configure your MXG and enable RPM channel as explained in section 10.1. RPM is one of the many data flowing from your ECU to MXG.

6.2 RPM via a 5-50 V Square Wave Signal or coil (150-400 V)

In case your engine is not managed by any ECU, MXG can read the signal from the low voltage of the coil (whose peak can be from 150 to 400 V) or from a possible square wave (the peak can be from 5 to 50V). The PIN labelled "rpm" reported in appendix "Pinout" receives the signal:

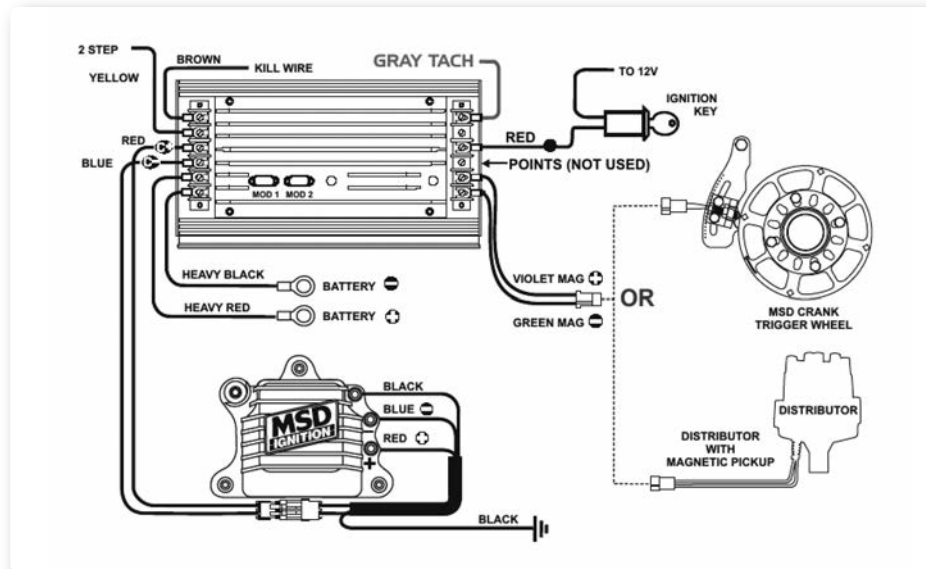

The image shows an example of wiring for the ignition system.

The output, labelled "GREY TACH" gives a 5-50V output that can be directly acquired from EVO4. If the output is not available from the ignition system, the system has to be connected to the low voltage of the coil, as shown in the following schematic.

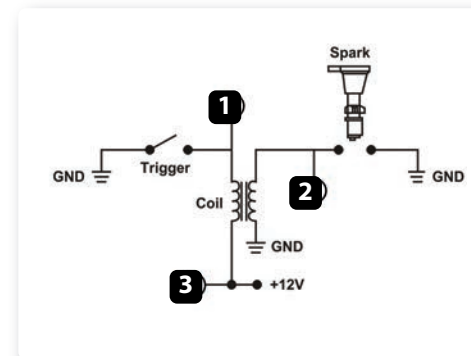
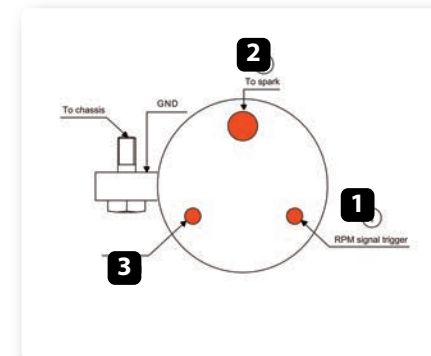

- Point 1:** Low voltage of the coil
- Point 2:** Connected to the spark plug
- Point 3:** Connected to the +12V of the battery

After connecting the RPM signal, please use the software Race Studio 3 for enabling the RPM channel, as explained in section 10.1.

7. Speed

MXG can receive the speed signal from three different sources:

- From the ECU
- From the GPS receiver included in the kit
- From the four digital channels

It is, therefore, possible for MXG to receive and store different values of speed at the same time; the more powerful ECUs transmit up to four wheel speed values.

7.1 Speed Read from ECU

If your ECU sends the value of speed in its data stream, it is obviously possible to read, record and show that value.

Simply enable use of the software RaceStudio3, as explained in section 10.1.

7.2 Speed Read from GPS Receiver

The GPS receiver integrated in the MXG kit is configured in order to obtain the best performance in terms of reactivity and accuracy.

For getting GPS speed, you don't need any configuration. Simply connect the GPS05 Module to your MXG, and after a setup period of some seconds, the data will be received and automatically recorded.

7.3 Speed Read from Wheel Sensors

MXG has four wheel speed inputs, one in the 37 pin connector and the other three in the 22 pin connector:

The digital sensor X05SNBS00 detects the presence of a metallic tooth placed at a distance between 0.5 and 2 mm.



Please use the software RaceStudio3 for configuring the system.

Just enter the program configuration panel and, after enabling the desired speed channels, set the wheel circumference and the number of pulses per revolution.

Id	<input checked="" type="checkbox"/>	Name	Function
RPM	<input checked="" type="checkbox"/>	RPM	<i>RPM</i>
Spd001	<input checked="" type="checkbox"/>	Speed001	<i>Vehicle Spd</i>
Spd002	<input checked="" type="checkbox"/>	Speed002	<i>Vehicle Spd</i>
Spd003	<input checked="" type="checkbox"/>	Speed003	<i>Vehicle Spd</i>
Spd004	<input checked="" type="checkbox"/>	Speed004	<i>Vehicle Spd</i>

8. Analog Inputs

MXG has 8 analog inputs, recorded up to 1000 times per second each. You can connect:

- 0-5 Volt signals
- Ratiometric potentiometers
- Pressure sensors
- Thermo-resistances
- K-type thermocouples

Please use the following steps, using the software RaceStudio3 as explained in section 10.1:

- Connect the sensor to the desired input
- Enable the channel in the Channels table
- Select the proper sensor type; sensors of many different types are properly handled
- Set the sampling frequency
- Set the unit of measure.

■ Temperature sensors

K thermocouples
Thermo-PT100 resistors
Temperature sensors VDO

■ Pressure sensors

VDO 40-120 ° C
VDO 50-150 ° C
VDO 60-200 ° C
MSI 0-2 bar
MSI 0-5 bar
MSI 0-10 bar
MSI 0-2000 psi

■ Potentiometers

Distance
Zero-based
Zero Central

■ Generic sensors

0-50 mV
0-500
0-5 V

9. Digital Output

MXG features two digital outputs in the 22 pins connector.

Each of them can give an output of 1 amp at 12 volts.

You can configure them in order to turn them on or off depending upon the value of the analog or digital inputs, ECU values, expansion values, GPS information or math channels.

To every event you can associate an alarm LED, a message and a digital output.

You can configure them in order to turn them off when the condition disappears, when you push a pushbutton, when the test is finished or when the data are downloaded after the test.

Please refer to section 10.1.4 in order to see how to manage the digital outputs.

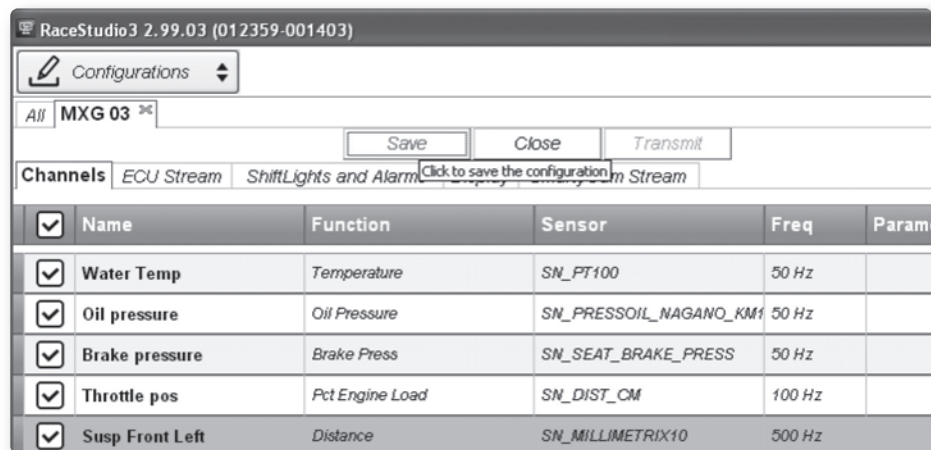

10. RaceStudio3 Software

RaceStudio3 is the powerful software that you are going to use for all the activities regarding your MXG. It offers the following features:

MXG configuration:

Create, modify, delete, export and import configurations of:

- Channels
- ECU drivers
- Math channels
- Display pages
- Alarm
- Digital outputs
- Shift lights
- All the expansions

When you start RaceStudio3, you can see a pushbutton in the upper left position of the screen; this lets you swap between different features:

- Configurations
- Track Manager
- Analysis
- Online e data download
- Movies Management
- Settings Preferences
- Web Update

Track maps management:

Create, import, export and modify the map of your racing tracks.
Transmit the maps to your MXG.

Test data download

From your MXG

Data analysis

For looking and compare your data

New firmware releases

downloaded from our site www.Aim-Sportline.com to upgrade your MXG automatically. RaceStudio3 software is provided on a CD included in the MXG kit or can be downloaded from www.Aim-Sportline.com in the "Download" area.



10.1 Configuration

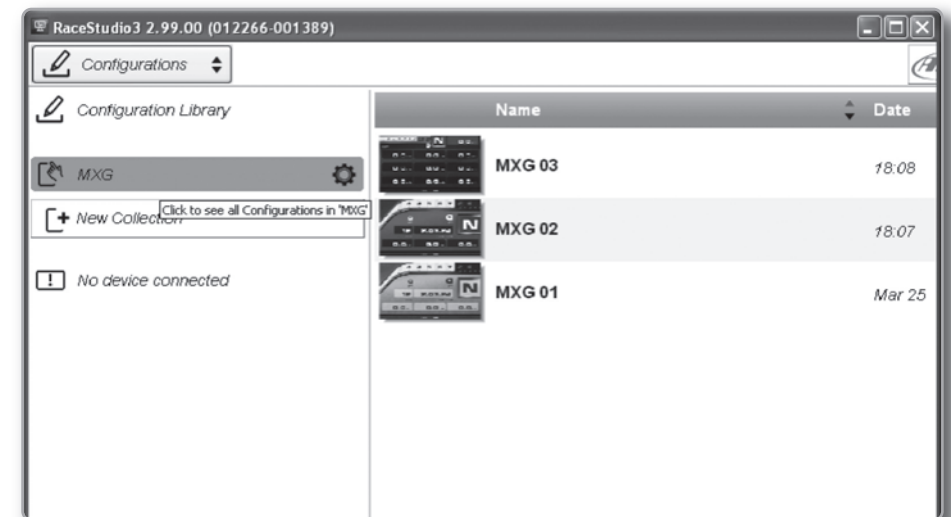

The configuration page is divided in two sections.

The left side is dedicated to the folders that you can create and manage in order to better organize your configurations. Simply push the [+] pushbutton in order to create a new one.

When you connect an AiM logger, like your MXG, its serial number appears in the left side of your screen. In the right side of the screen you can see all the configurations of the selected folder. Please click on the desired one for editing it or push the "NEW" pushbutton for creating a new one.

Please don't forget to select the proper ECU brand and model to which connect your MXG.

After having entered the MXG configuration page, you can see different tabs, which are useful for selecting one of the following configuration features:

- Overlay
- Shiftlights and Alarm
- Channels
- ECU stream

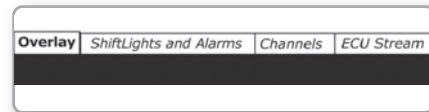
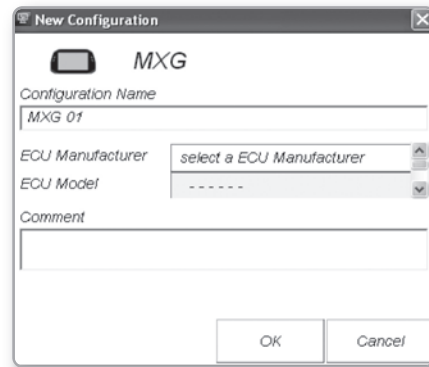

10.1.1 Display Configuration

After selecting the **OVERLAY** configuration feature, the following page appears:



It is divided in two different sections.

On the right, you can select one among different layouts, while on the right you will manage the different fields, selecting the proper information to be shown, the parameters, labels and the units of measure.

You can add up to eight pages.

Please use the lower left part of the display for configuring each channel.

You can define:

- The channel
- The name
- The unit of measurement
- The end of scale for every channel shown on the page

When the panel shows the desired configuration, push **"SAVE"** or **"CLOSE"** for saving the configuration.

In case you have connected your MXG to the PC, a **"TRANSMIT"** pushbutton is available for transmitting the new configuration to your device.

10.1.2 Channels configuration

Push the tab CHANNELS:

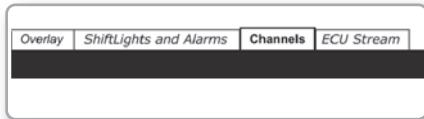

The channel configuration page will appear

With this page you can define all the parameters for your analog inputs, speed inputs and digital RPM input.

Id	<input checked="" type="checkbox"/>	Name	Function	Freq	Parameters
RPM	<input checked="" type="checkbox"/>	RPM	RPM	20 Hz	
Spd001	<input checked="" type="checkbox"/>	Speed001	Vehicle Spd	20 Hz	
Spd002	<input checked="" type="checkbox"/>	Speed002	Vehicle Spd	20 Hz	
Spd003	<input checked="" type="checkbox"/>	Speed003	Vehicle Spd	20 Hz	
Spd004	<input checked="" type="checkbox"/>	Speed004	Vehicle Spd	20 Hz	
Ch001	<input checked="" type="checkbox"/>	Channel001	Pct	20 Hz	
Ch002	<input checked="" type="checkbox"/>	Channel002	Pct	20 Hz	
Ch003	<input checked="" type="checkbox"/>	Channel003	Pct	20 Hz	

By clicking on every line, a menu appears:

You can define:

- The name of the channel
- The function
- The position
- Eventually, the sensor used
- The sampling frequency



10.1.3 ECU stream configuration

With this feature, you can enable or disable the data coming from your ECU, and you can define the frequency for every channel and change their name.



10.1.4 Alarm LEDs, Digital Output and Shift Lights

Click **"Shift Lights and Alarms"** for managing the Shift Light LEDs, Alarm LEDs and Digital Outputs.

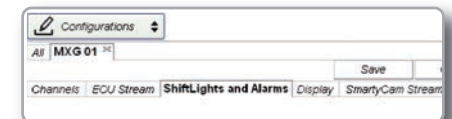



Shift Lights Configuration

Using the configuration bar you can manage, for every LED, color and RPM threshold value which will turn it on.

Pushing the pushbutton **“Option”** you can decide if:

- To keep the LED ON if its threshold is exceeded
- To keep the LED ON only till another LED is turned ON

and if the LEDs are managed in dependence upon the gear number. In this case, per every gear number you have to define the levels at which to turn them on.

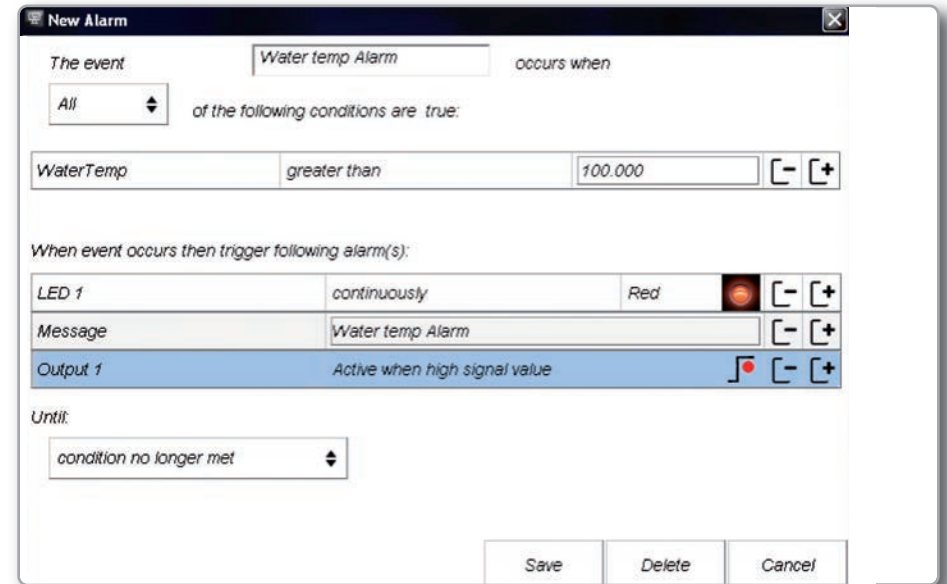
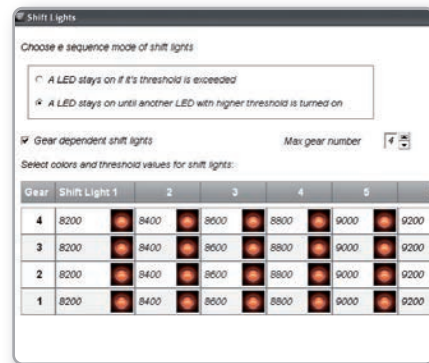

Alarms configuration

When you click **“Add new alarm”** the window shown in the above picture appears: here you can define the event the system has to check and the effect of that event.

- 1) Fill the DESCRIPTION field, in order to easily identify the event in the future.
- 2) Describe the Alarm: it can be a simple event, like, for example:

“water temperature is higher than 100 °C”

or a combination of multiple events, like, for example:

“water temperature is higher than 100 °C”

“Engine RPM is higher than 6000”
You can add different check lines and define the alarm as a combination of ALL the events or just ONE of them.

3) Describe what to do when an alarm arises. MXG can:

- Turn a LED ON: You have to select the color and the behaviour (fast/slow blinking or continuous).

- Show a TEXT MESSAGE that you have to define.

Turn one of the two Digital Outputs ON

4) finally, you have to configure till when the alarm has to remain in evidence.

There are some options:

- Till when the condition remains ON
- Till when the driver pushes a pushbutton
- Till when the power is turned OFF
- Till when the data are downloaded to the PC.

Once configurations are set, a summary will appear: any time you need to change settings, just click on the icon and proceed.

The icon at its left recalls the condition you chose to turn the LED off.

10.1.5 Modify or Delete an Existing Configuration

For modifying or deleting an existing configuration, select the desired configuration to be modified and double click on it:



Then, proceed like in the creation of the configuration.

10.2 Connect Your MXG to a PC

When you connect your MXG to the PC, it is automatically recognized, and on the left side of the PC display appears the name of your device, as shown in the picture.

At this point, you can execute the following functions:

- Transmit the configuration
- On Line view
- Calibration
- Data download

This is explained in the next paragraphs.

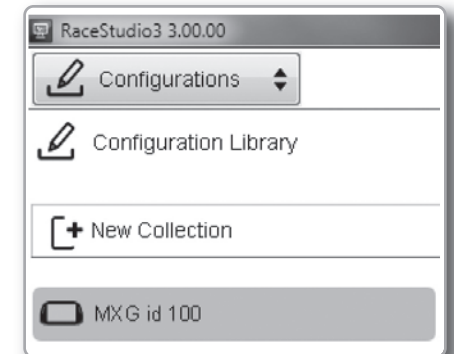

10.2.1 Configuration Transmission

When you connect an MXG to your PC, the **“TRANSMIT”** pushbutton appears at the top of the configuration page.

Simply push it and the configuration will be transmitted.



10.2.2 On Line View and Calibration

Master Clk	474658	ms	Lap Time		AP Packet 2k	Pckt	GPS	No GPS	Pckt	
Logger Temperat	-99.9	C	Battery Voltage	0	mV	RPM	0	rpm		
Speed001	0.0	km/h	Speed002	0.0	km/h	Speed003	0.0	km/h		
Speed004	0.0	km/h	Channel001	0	mV	Channel002	0	mV		
Channel003	0	mV	Channel004	0	mV	Channel005	0	mV		
Channel006	0	mV	Channel007	0	mV	Channel008	0	mV		
Accelerometer001	0.00	g	Accelerometer002	0.00	g	Accelerometer003	0.00	g		
F88_RPM	6900	rpm	F88_PPSA	12.20	%	F88_V_SPEED	248.4	km/h		
F88_D_SPEED	158.0	km/h	F88_SPEED_FL	157.3	km/h	F88_SPEED_FR	157.4	km/h		
F88_SPEED_RL	157.5	km/h	F88_SPEED_RR	157.6	km/h	F88_LONG_ACC	-0.20	g		
F88_LAT_ACC	-3.90	g	F88_MAP1	563.00	bar	F88_MAP2	1101.00	bar		
F88_TRBO_SPD1	12	rpm/s	F88_TRBO_SPD2	12	rpm/s	F88_LAMBDA1	1.00	lambda		
F88_LAMBDA2	1.00	lambda	F88_ACT1	81.1	C	F88_ACT2	91.1	C		
F88_ECT1	640.0	C	F88_ECT2	-6.4	C	F88_EGT1	82.1	C		
F88_EGT2	92.1	C	F88_FUEL_CONS	89	l	F88_GEAR	-	#		
F88_OIL_P1	6.90	bar	F88_OIL_P2	1.70	bar	F88_OIL_P3	1.80	bar		
F88_OIL_P4	1.90	bar	F88_V_BATT	12	mV	F88_FUEL_PR1	1.20	bar		
F88_FIPI_P2	1.30	bar	F88_FOT	85.1	C	F88_FIPI_T	31.1	C		

Push **"LIVE MEASURE"** for looking at the data coming from your MXG.

From the Online View, you can calibrate the channels that require calibration.

10.2.3. DataDownload

Name	Date	Size
m_0002.xrk	08/04/2014 14:31	371 KB
m_0001.xrk	08/04/2014 14:27	30 KB

Push **"DOWNLOAD"** for downloading the data recorded in your MXG.

You will see the information about the files recorded in the system: dimension and date/time of the file creation.

Please select a file and push **"DOWNLOAD"** for getting it into your PC.

11. GPS

The GPS Module, included in the MXG kit, provides the following information updated ten times per second:

- Position (latitude, longitude, altitude)
- Speed
- Longitudinal acceleration
- Lateral acceleration

In the case that MXG knows the finish line of the track and the split coordinates, it can calculate and show:

- Lap Times
- Split times

To transmit track information to MXG, use the Track Manager feature, as explained in the following section.

11.1 Track Manager Feature

With Track Manager, you can update, modify, transmit and receive to and from MXG the coordinates of the finish line and split points of all the tracks where you are going to run.

When opening the software, if there is no system connected to your PC via USB cable, you will see the screen shown.

As you can see, the screen is divided into two parts.

On the left you see the track list.

If available, you will see the track layout and the type of vehicle that usually races on the track: car, motorcycle or kart.

On the right side of the screen, you will find a big picture of the track.

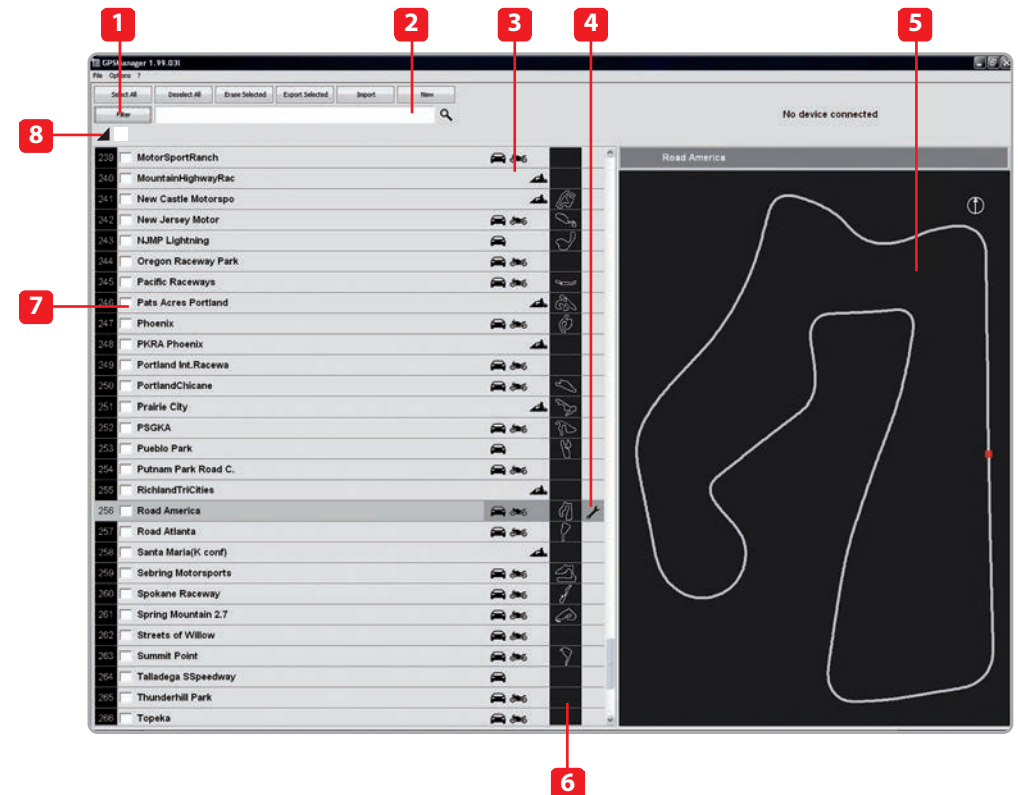

- 1 Track management command
- 2 Selection window for dynamic filters
- 3 Track type: car, bike, karts
- 4 Track data manager
- 5 Track shape, with starting line and split points position
- 6 Small track shape
- 7 Track selection
- 8 Open/Close Country track data



11.2 Filters in Track Data Base Management

You can filter the list of tracks you need in different ways.

The filters can be static (1) that is to say, are recorded and used every time you use Track Manager, or dynamic (2) that are not saved when quitting the program.

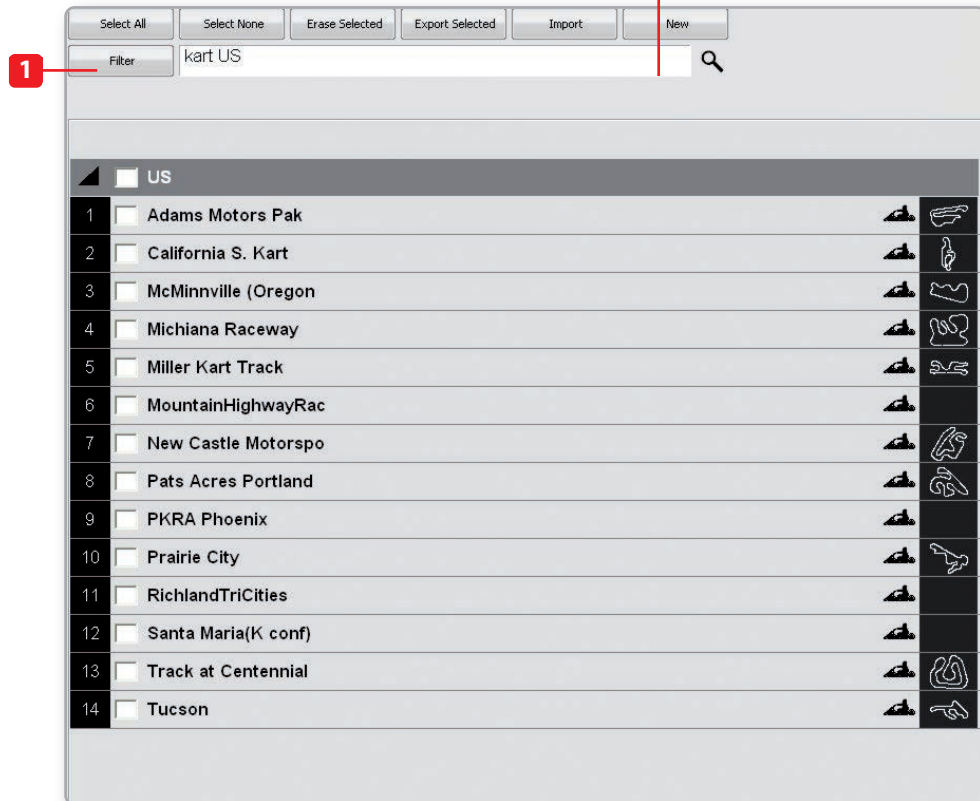

Static Filters

A static filter is activated by the button "filter" [1].

The window shown here will appear.

It will allow you to select nations, the type of vehicle and type of circuit.

The lists show only countries, vehicles and types of circuits present at least once in the database.

For example, if the database does not include any track in Germany, this country will not appear in the list.

By default, all countries, types of vehicles and tracks are enabled.

If you are interested in only the car tracks, for example, you must disable karts and motorcycles.



Dynamic Filters

The dynamic filters are activated in the box at the top left of the screen [2]:

The dynamic filters allow you to further filter the tracks merging different characteristics.

For example, when writing "Spain kart," you will see only kart circuits in Spain.

11.3 How to Add a New Track to the PC Database

The official AiM track Database is continuously growing. To update your PC database, you can import the new tracks:

Press **“Options”** then **“Import Tracks from AiM Website”**.

To add a new track:

1) Press the button **“New.”**

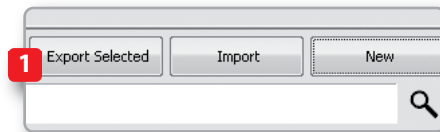

2) Enter the name of the track.

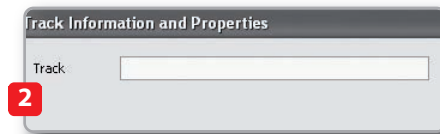

3) Enter the required information:

Country, type of circuit (**closed, oval or open**) and surface (**asphalt, dirt, ice, or water**).

Finally, using the icon buttons, set the type of vehicle that usually runs on the circuit: **cars, motorcycles or karts**.

If you have already run a test on the track and have downloaded data, you can associate the shape of the track by pressing the **“Load Shape”** button.

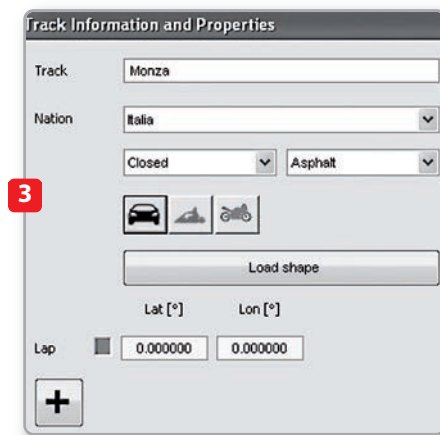

You can now select the file **“.GPK”** containing the GPS

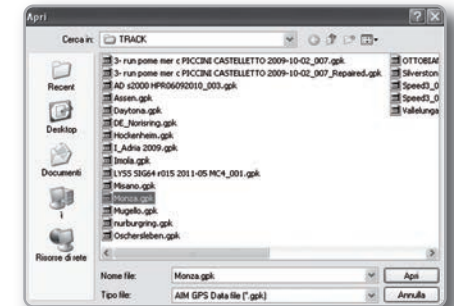

Map of your track session

Please select the proper file, carefully checking name, date and time of the files.

The shape of the track appears, split in different laps of the test. It is possible to scroll through the different laps, zoom and rotate the drawing.

After having selected the desired lap, push **“OK”** to save the image of that lap. That image will be used as a reference shape for the future.

Finish line coordinates are automatically calculated but can be modified as desired in one of the following ways:

Define the coordinate by hand: position the cursor on the desired point of the track and click the **“Cursor Pos”** pushbutton.

In case of a point-to-point track, it is necessary to define the coordinates of the starting and finish line. Push **“OK”** to save the configuration.

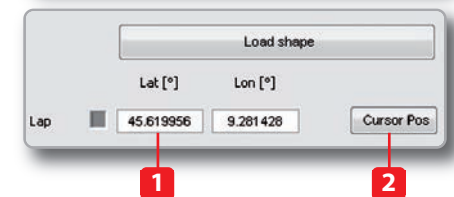

11.4 How to Modify Track Data in the PC Database

Click the icon on the side.
The window containing the track data will open.

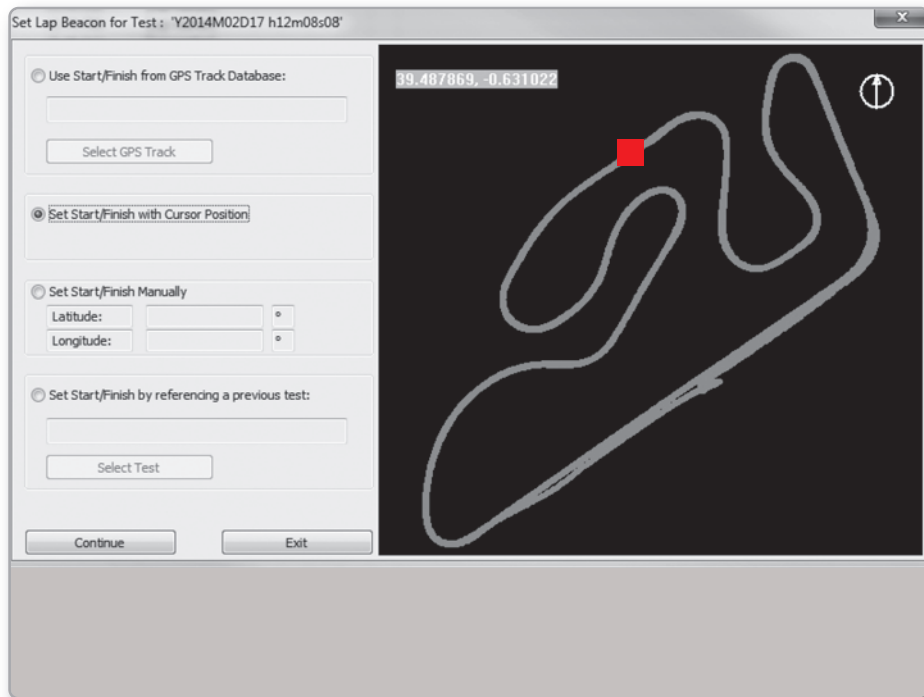

11.5 How to Read, Write and Delete Tracks Information in MXG

Connect your system to your PC using the USB cable.

The Track Manager screen will display two lists.

On the left are the tracks in your PC and on the right are the tracks in MXG.

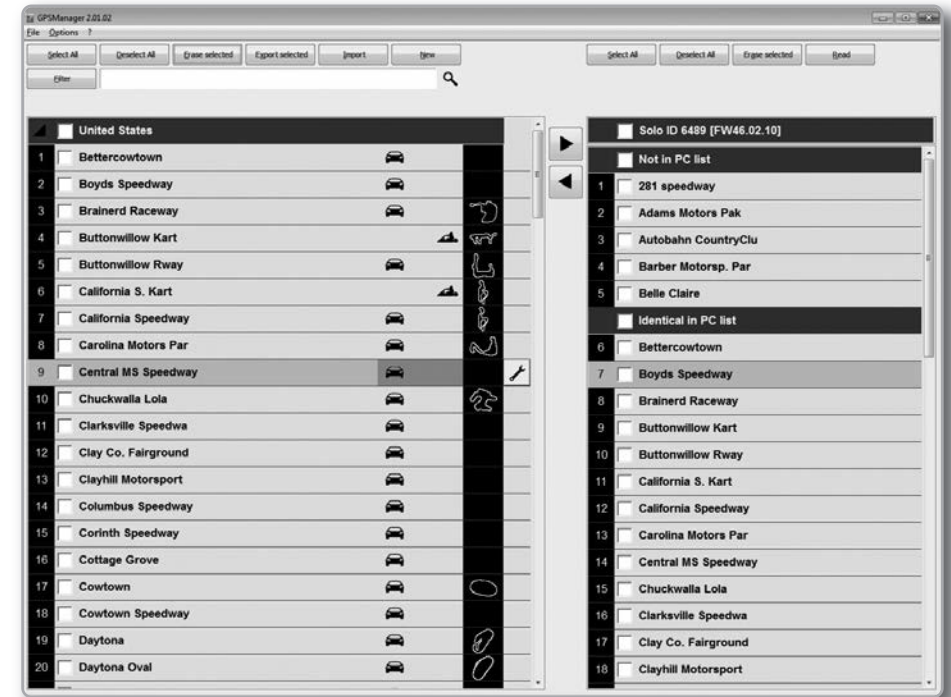

To transmit track information to MXG

To receive track information from MXG

Select tracks to be submitted by clicking on the square check or on the name of the track.

Select tracks to be submitted by clicking on the square check or on the name of the track.

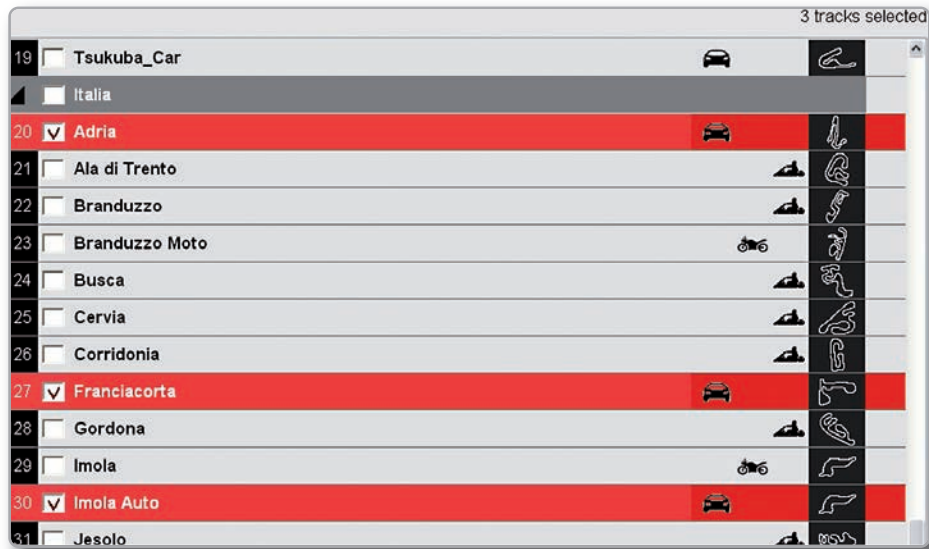

1



2

Drag in the right panel or press the ► button. The tracks' information are updated in the SmartyCam panel.

Drag in the left panel or press the ◀ button. Tracks' information are updated in the PC list.

12. Expansion



Add expansion modules via our built in CAN bus eg. GPS, external memory modules, channel expansions, lambda controllers. These are only some of the items that can be added to our MXG range for incrementing the performance and the data acquired.

13. MXG Pinout

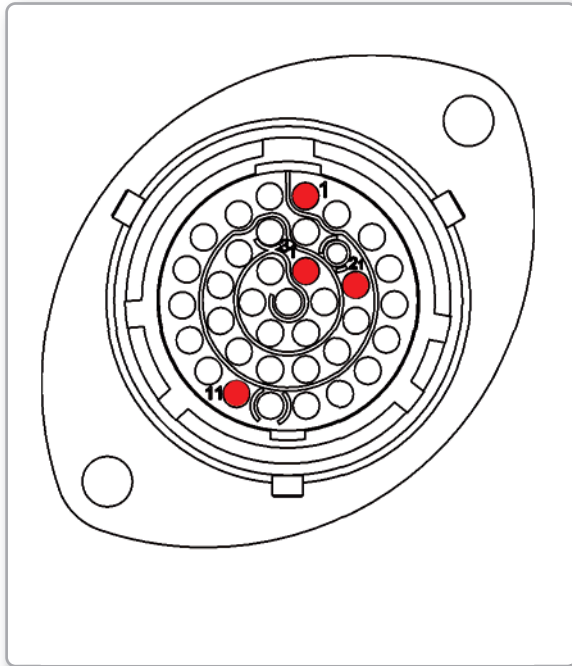

PIN	Deutsch 37pin.
01	9-15V power in
02	gnd batt
03	can+ Exp
04	gnd
05	+Vbatt can
06	can- Exp
07	+Vbext
08	Can1+ ECU
09	Can1- ECU
10	gnd
11	k line ECU
12	USB D+
13	USB D-
14	gnd
15	rpm
16	gnd
17	+Vbatt
18	Optical lap
19	speed1
20	gnd
21	+Vbatt
22	Ain1
23	gnd analog
24	+Vbatt
25	+Vref
26	Ain2
27	gnd analog
28	+Vbatt
29	+Vref
30	Ain3
31	gnd analog
32	+Vbatt
33	+Vref
34	Ain4
35	gnd analog
36	+Vbatt
37	+Vref

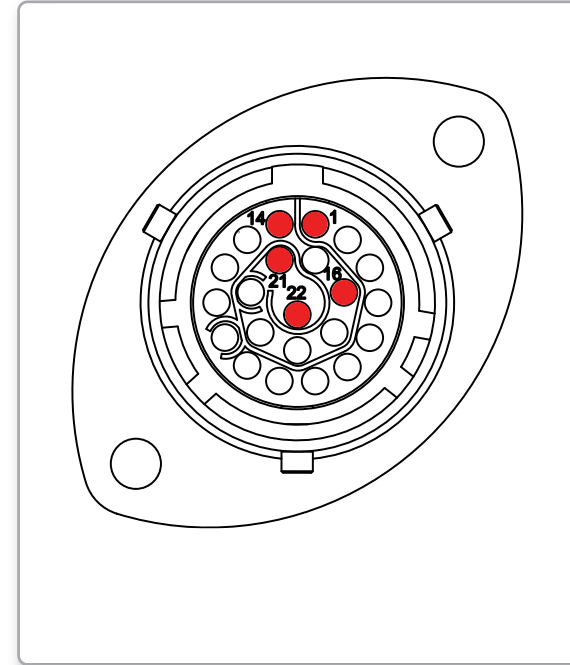

PIN	Deutsch 22pin.
01	Ain5
02	gnd analog
03	+Vbatt
04	+Vref
05	Ain6
06	Ain7
07	gnd analog
08	+Vbatt
09	+Vref
10	Ain8
11	speed2
12	gnd
13	+Vbatt
14	speed 3
15	speed4
16	gnd
17	Can2+ ECU
18	Can2- ECU
19	Dout1
20	Dout2
21	rs232 TX ECU
22	rs232 RX ECU



Deutsch 37pin.

Deutsch 22pin.

Motorsport Connectors

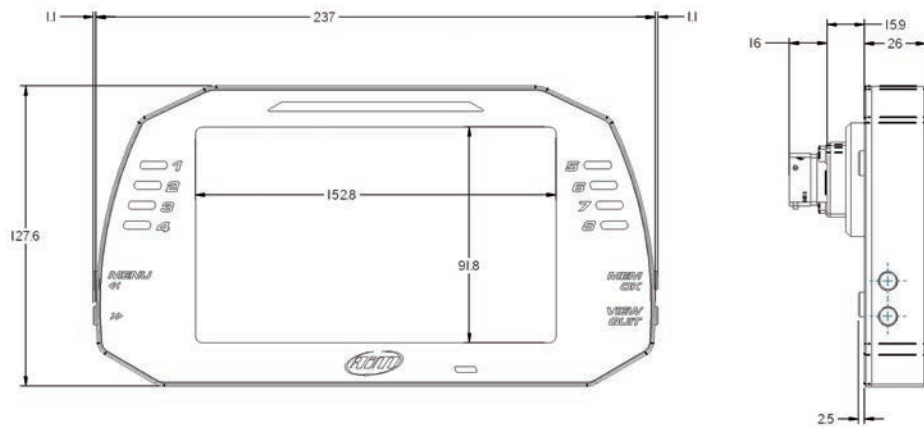

- Display	7" TFT display
- Pixel	800 x 480
- Contrast	1000:1
- Brightness	700cd/m2
- Light sensor	Yes
- Alarm LEDs	8 RGB freely configurable
- Shift Lights	10 RGB LEDs freely configurable
- CAN connections	3
- Expansion CAN connection	GPS, Channel expansion, Lambda Controller, SmartyCam
- ECU connections	CAN, RS232 or OBDII
- Digital outputs	2 1A 12v
- Analog inputs	8 fully configurable
- Digital inputs	4 Speed inputs, 1 RPM input
- Connectors	2 Motorsport connectors
- Accelerometer + Gyroscope	Internal Three-axial $\pm 5G$ +Gyro
- Internal memory	4 GB
- Body	Anodize Aluminum
- Pushbuttons	Metallic
- Dimensions	237x127,6x26mm
- Weight	950g
- Waterproof	IP65



Our web site aim-sportline.com is constantly updated.

Please, constantly check it and download the last versions of the firmware of your products.

